



RAZER KIYO

MASTER GUIDE

Designed and tested by top streamers, the Razer Kiyo is a desktop streaming camera with a powerful, multi-step ring light that you can dim or brighten on command, and the ability to stream at 60 fps for full gaming fidelity. It's the perfect camera for professional streaming.

CONTENTS

1. PACKAGE CONTENTS / SYSTEM REQUIREMENTS	3
2. REGISTRATION / TECHNICAL SUPPORT.....	4
3. TECHNICAL SPECIFICATIONS.....	5
4. DEVICE LAYOUT.....	6
5. SETTING UP YOUR RAZER KIYO.....	7
6. USING YOUR RAZER KIYO.....	9
7. SAFETY AND MAINTENANCE	10
8. LEGALESE.....	11

1. PACKAGE CONTENTS / SYSTEM REQUIREMENTS

PACKAGE CONTENTS

- Razer Kiyo broadcasting camera
- Important Product Information Guide

SYSTEM REQUIREMENTS

- PC with a free USB port
- Windows® 7 (or higher)
- Internet connection
- 500 MB of free hard disk space¹
- Third party software:
Open Broadcaster Software [obsproject.com] or XSplit² [xsplit.com]

¹ Increased system requirements and additional software may be required for certain applications.

² Software license fee may apply.

2. REGISTRATION / TECHNICAL SUPPORT

REGISTRATION

Register your product online at razer-id.razerzone.com/warranty using your Razer ID to get real-time information on your product's warranty status.

If you haven't registered for a Razer ID yet, register now at razerzone.com/razer-id to get a wide range of Razer benefits.

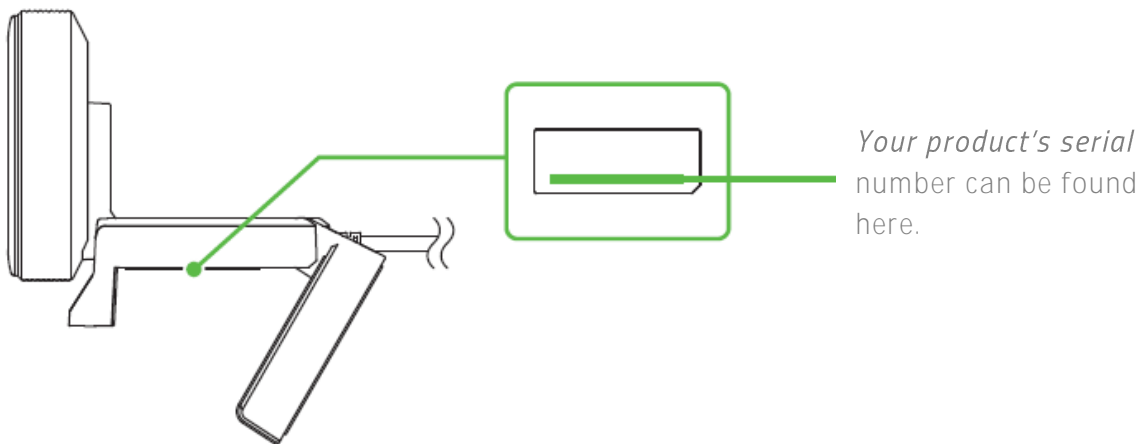

TECHNICAL SUPPORT

What you'll get:

- 1 year limited manufacturer's warranty.
- Free online technical support at support.razerzone.com

3. TECHNICAL SPECIFICATIONS

TECHNICAL SPECIFICATIONS

Camera Specifications

- Connection type: USB2.0
- Image resolution: 4 Megapixels
- Video Resolution: 1080p @ 30FPS / 720p @ 60FPS / 480p @ 30FPS / 360p @ 30FPS
- Video encoding: YUY2/MJPEG or H.264
- Still Image Resolution: 2688x1520
- Image Quality Settings Customization: Yes
- Diagonal Field of View (FOV): 81.6 °
- Focus Type: Auto
- Mounting Options: L-shape joint and Tripod (Not included)
- Cable Length: 1.5 meters braided cable

Ring light specifications

- Illumination: 12 white LEDs
- **Color Temperature: 5600K "daylight"**
- LED Diffuser: Milky White
- Buttons: 12 step ring dial
- Brightness: 10 Lux @ 1m

Microphone Specifications

- Audio Codec: 16bit 48KHz
- Polar patterns: Omnidirectional
- Sensitivity: -38dB

APPROXIMATE SIZE & WEIGHT

- Diameter: 68.7 mm / 2.70 in
- Height: 50 mm / 1.96 in
- Weight: 170 g / 0.374 lbs

4. DEVICE LAYOUT

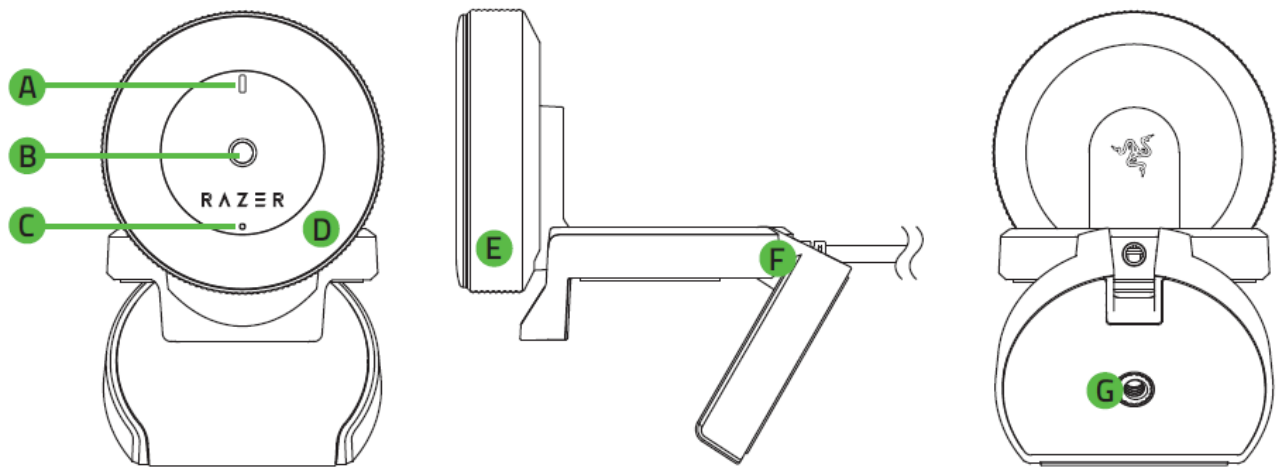

- A. LED indicator
- B. Full HD 1080p lens
- C. Built-in microphone
- D. Ring light with LED diffuser
- E. Ring light adjustment knob
- F. Flexible clip
- G. Thread mount

5. SETTING UP YOUR RAZER KIYO

1. Connect the Razer Kiyo to the USB port of your computer. The LED indicator of your camera will light up, indicating that the device is active.

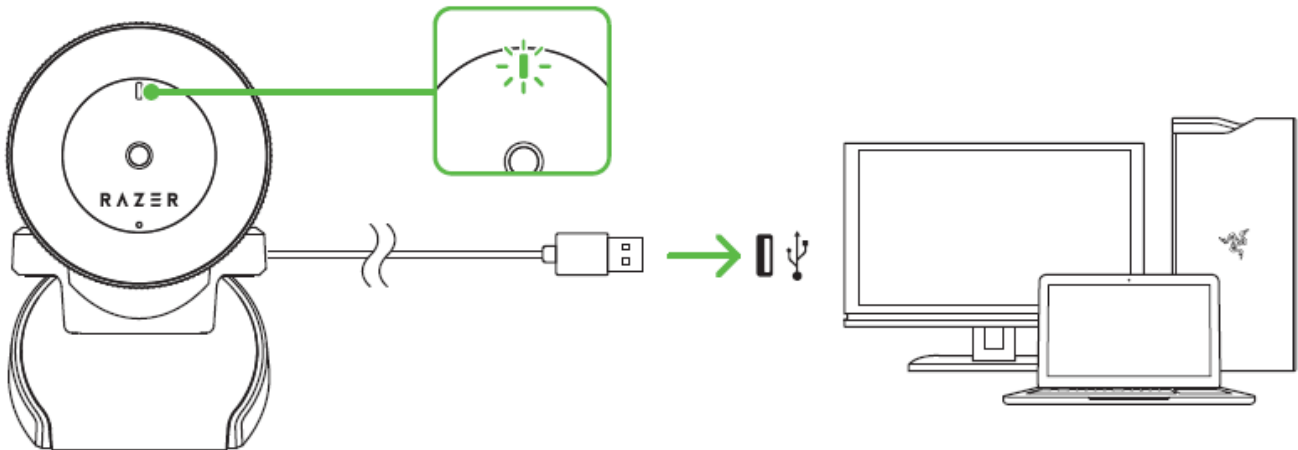

2. Use the flexible clip to place the Razer Kiyo on top of monitors, TVs, or on almost any surface with ease. You may also attach the Razer Kiyo to a tripod* using the thread mount under the flexible clip. (*not included)

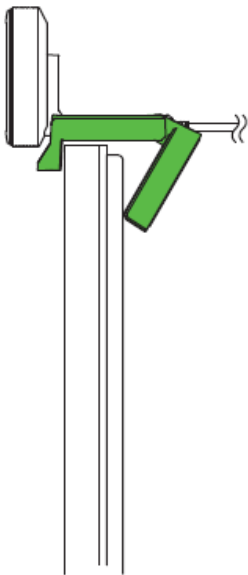

Monitors, Laptops, TVs

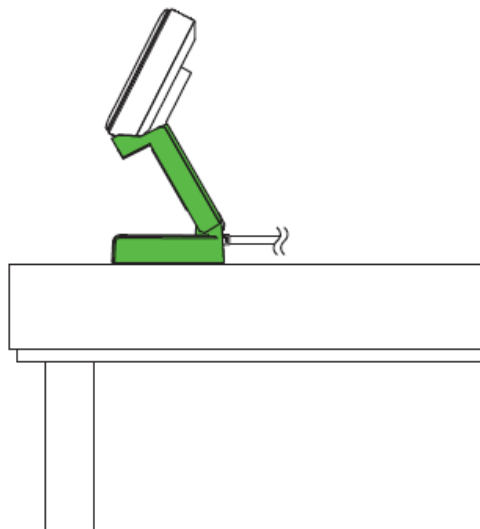

Desks

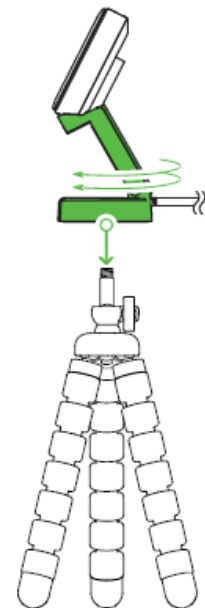

Tripods

Note: Ensure that your position is free of clutter and moving objects. Move mirrors and other reflective objects that are visible to the camera.

3. Position yourself within 50-100 centimeters in front of the Razer Kiyo.

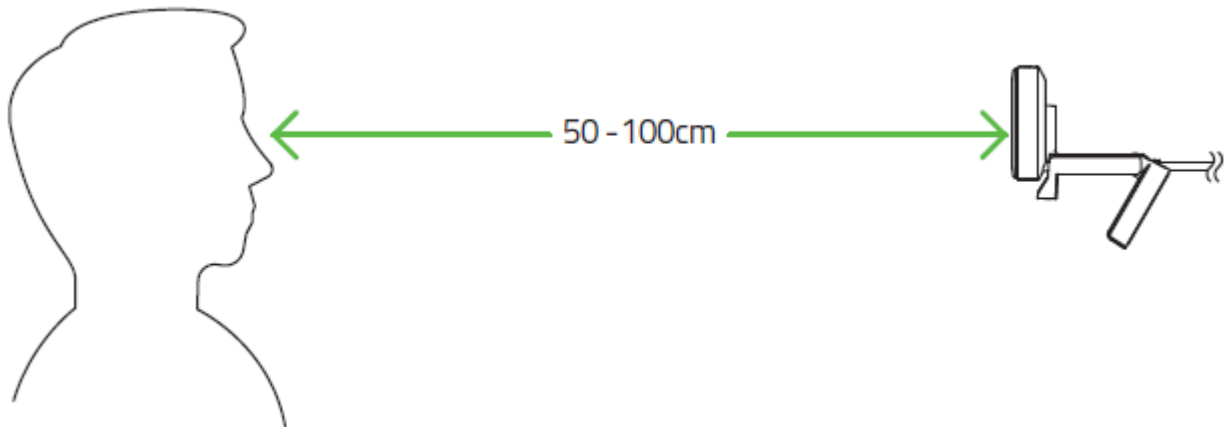

6. USING YOUR RAZER KIYO

DOWNLOADING APPS FOR THE RAZER KIYO

Visit razerzone.com/razer-kiyo to check out all the camera and third party applications compatible with your Razer Kiyo that enable **your camera's** various features*. Simply download and install any supported app and set the Razer Kiyo as its capture device.

* Some apps are trial-based and/or may require purchase to use.

ADJUSTING THE RING LIGHT BRIGHTNESS

The **camera's** ring light is automatically enabled when you launch a compatible camera or third party broadcasting software with the Razer Kiyo set as its capture device.

You may then rotate the Ring light adjustment knob clockwise or counterclockwise to increase or decrease the brightness of the ring light as needed.

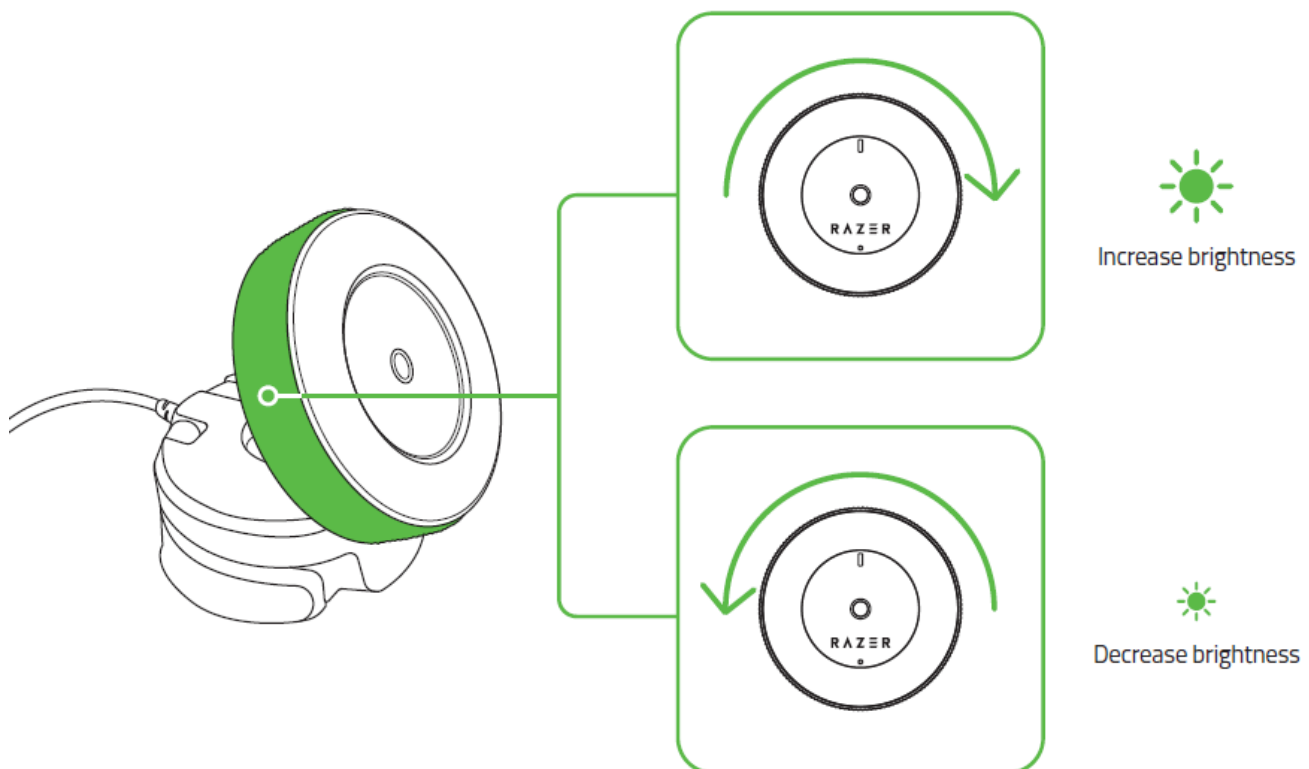

7. SAFETY AND MAINTENANCE

SAFETY GUIDELINES

In order to achieve maximum safety while using the Razer Kiyo, we suggest that you adopt the following guidelines:

Should you have trouble operating the device properly and troubleshooting does not work, unplug the device and contact the Razer hotline or go to support.razerzone.com for support.

Do not take apart the device (doing so will void your warranty) and do not attempt to operate it under abnormal current loads.

Do not use or install the device and its components near water, moisture, solvents, or other wet surfaces, nor expose the device to high temperatures or direct sunlight for an extended period of time.

Keep the device and its components away from liquid, humidity or moisture. Operate the device and its components only within the specific temperature range of 0°C (32°F) to 40°C (104°F). Should the temperature exceed this range, unplug and switch off the device in order to let the temperature stabilize to an optimal level.

MAINTENANCE AND USE

The Razer Kiyo requires minimum maintenance to keep it in optimum condition. Once a month we recommend you unplug the device from the computer and clean it using a soft cloth or cotton to prevent dirt buildup. Do not use soap or harsh cleaning agents.

8. LEGALESE

COPYRIGHT AND INTELLECTUAL PROPERTY INFORMATION

©2017 Razer Inc. All rights reserved. Razer, the triple-headed snake logo, Razer logo, "For Gamers. By Gamers.", and "Powered by Razer Chroma" logo are trademarks or registered trademarks of Razer Inc. and/or affiliated companies in the United States or other countries.

Windows and the Windows logo are trademarks or registered trademarks of the Microsoft group of companies.

XSplit and XSplit Broadcaster are registered trademarks of Splitmedialabs Limited. All other trademarks are registered to their respective owners.

Razer Inc. ("Razer") may have copyright, trademarks, trade secrets, patents, patent applications, or other intellectual property rights (whether registered or unregistered) concerning the product in this guide. Furnishing of this guide does not give you a license to any such copyright, trademark, patent or other intellectual property right. The Razer Kiyo (the "Product") may differ from pictures whether on packaging or otherwise. Razer assumes no responsibility for such differences or for any errors that may appear. Information contained herein is subject to change without notice.

LIMITED PRODUCT WARRANTY

For the latest and current terms of the Limited Product Warranty, please visit razerzone.com/warranty.

LIMITATION OF LIABILITY

Razer shall in no event be liable for any lost profits, loss of information or data, special, incidental, indirect, punitive or consequential or incidental damages, arising in any way out of distribution of, **sale of, resale of, use of, or inability to use the Product.** In no event shall Razer's liability exceed the retail purchase price of the Product.

COSTS OF PROCUREMENT

For the avoidance of doubt, in no event will Razer be liable for any costs of procurement unless it has been advised of the possibility of such damages, and in no case shall Razer be liable for any costs of procurement liability exceeding the retail purchase price of the Product.

GENERAL

These terms shall be governed by and construed under the laws of the jurisdiction in which the Product was purchased. If any term herein is held to be invalid or unenforceable, then such term (in so far as it is invalid or unenforceable) shall be given no effect and deemed to be excluded without invalidating any of the remaining terms. Razer reserves the right to amend any term at any time without notice.