



Intel® RealSense™ Depth Camera D400-Series

(Intel® RealSense™ Depth Camera D415,
Intel® RealSense™ Depth Camera D435)

Datasheet

September 2017

Revision 0.7



You may not use or facilitate the use of this document in connection with any infringement or other legal analysis concerning Intel products described herein. You agree to grant Intel a non-exclusive, royalty-free license to any patent claim thereafter drafted which includes subject matter disclosed herein.

No license (express or implied, by estoppel or otherwise) to any intellectual property rights is granted by this document.

Intel technologies' features and benefits depend on system configuration and may require enabled hardware, software or service activation. Learn more at Intel.com, or from the OEM or retailer.

No computer system can be absolutely secure. Intel does not assume any liability for lost or stolen data or systems or any damages resulting from such losses.

The products described may contain design defects or errors known as errata which may cause the product to deviate from published specifications. Current characterized errata are available on request.

Intel disclaims all express and implied warranties, including without limitation, the implied warranties of merchantability, fitness for a particular purpose, and non-infringement, as well as any warranty arising from course of performance, course of dealing, or usage in trade.

Intel technologies' features and benefits depend on system configuration and may require enabled hardware, software or service activation. Learn more at intel.com, or from the OEM or retailer.

All information provided here is subject to change without notice. Contact your Intel representative to obtain the latest Intel product specifications and roadmaps.

Copies of documents which have an order number and are referenced in this document may be obtained by calling 1-800-548-4725 or visit www.intel.com/design/literature.htm.

By using this document, in addition to any agreements you have with Intel, you accept the terms set forth below.

Contact your local Intel sales office or your distributor to obtain the latest specifications and before placing your product order.

Intel, RealSense and the Intel logo are trademarks of Intel Corporation in the U.S. and/or other countries.

*Other names and brands may be claimed as the property of others.

Copyright © 2017, Intel Corporation. All rights reserved.

Contents

1	Description and Features	7
2	Introduction	8
	2.1 Disclaimer	8
	2.2 Purpose and Scope of this Document	8
	2.3 Terminology	8
	2.4 Overview	9
	2.4.1 Intel® RealSense™ Depth Camera D400-Series SKUs	9
	2.5 Stereo Vision Depth Technology Overview	11
	2.6 D400-Series Camera Block Diagram	12
	2.7 Depth Module	13
	2.7.1 Left and Right Imagers	15
	2.7.2 Infrared Projector	17
	2.7.3 Color Camera	17
	2.8 Color Image Signal Processor (ISP)	18
	2.9 Intel® RealSense™ Vision Processor D4 Card	18
	2.9.1 Power Requirements	19
	2.10 D400-Series Depth Cameras Thermals	20
	2.11 Storage and Operating Conditions	20
3	Functional Specification	21
	3.1 Depth Camera	21
	3.2 Depth Camera Functions	22
	3.3 Color Camera Functions	23
4	Software Package	24
	4.1 Intel® RealSense™ Software Development Kit 2.0	24
5	Firmware	25
	5.1 Firmware Update	25
	5.1.1 Update Limits	25
	5.2 Recovery	25
6	Calibration Support	26
	6.1 Dynamic Calibration Tool	26
7	Regulatory Compliance	27
	7.1 System Laser Compliance	27
	7.1.1 Certification Statement	27
	7.1.2 Explanatory Label	27
	7.1.3 Cautionary Statements	27
	7.1.4 Safety and Handling Instructions:	28
	7.1.5 Manufacturer's Information	28
	7.1.6 US FDA Accession Number	28
	7.2 Ecology Compliance	29
8	Mechanical Drawings	31

Figures

Figure 2-1. Intel® RealSense™ Depth Camera D415.....	10
Figure 2-2. Intel® RealSense™ Depth Camera D435.....	11
Figure 2-3. Active Infrared (IR) Stereo Vision Technology.....	12
Figure 2-4. Depth Measurement (Z) Versus Range (R)	12
Figure 2-5. D415/D435 System Block Diagram.....	13
Figure 2-6. Depth Module in D415 (Intel® RealSense™ Depth Module D415).....	14
Figure 2-7. Depth Module in D435 (Intel® RealSense™ Depth Module D430).....	14
Figure 2-8. Intel® RealSense™ Vision Processor D4 Card	19
Figure 8-1. Intel® RealSense™ Depth Camera D415.....	31
Figure 8-2. Intel® RealSense™ Depth Camera D435.....	32

Tables

Table 2-1. Product SKU Descriptions	9
Table 2-2. Intel® RealSense™ Depth Camera D415 Mechanical Dimensions	10
Table 2-3. Intel® RealSense™ Depth Camera D435 Mechanical Dimensions	10
Table 2-4. Depth Module	14
Table 2-5. Depth Module SKU Properties.....	15
Table 2-6. Standard Left and Right Imager Properties (for D415)	16
Table 2-7. Wide Left and Right Imager Properties (for D435)	16
Table 2-8. Standard Infrared Projector Parameters	17
Table 2-9. Wide Infrared Projector Parameters	17
Table 2-10. Color Sensor Properties	18
Table 2-11. ISP Properties	18
Table 2-12. Intel® RealSense™ Vision Processor D4 Card Components	19
Table 2-13. Power Requirements	20
Table 2-14. Max Skin Temperature	20
Table 2-15. Storage and Operating Conditions.....	20
Table 3-1. Intel® RealSense™ Depth Camera D400 Series Image Formats	21
Table 3-2. Depth Camera Controls	22
Table 3-3. RGB (Integrated) Exposed Controls	23

Revision History

Revision Number	Description	Revision Date
0.7	Initial Release	September 2017

§ §

1 Description and Features

<p>Description</p> <p>The Intel® RealSense™ Depth Camera D415/D435 is an USB-powered camera that includes depth sensors and a RGB sensor. It is ideal for makers, educators, hardware prototyping and software development. The camera peripheral is designed for ease of setup and portability.</p> <p>The Intel® RealSense™ Depth Camera D415/D435 comes with Intel® RealSense™ SDK 2.0 , an open source and cross platform enabling suite including rappers, sample code and tools.</p> <p>Usages/Markets</p> <ul style="list-style-type: none"> • Augmented Reality, Virtual Reality • Mobile • Autonomous Machines • Automotive • Broad Market • <p>Minimum System Requirements</p> <ul style="list-style-type: none"> • 6th Generation Intel® Processors (Skylake) and above. <ul style="list-style-type: none"> • Ubuntu*16.04/Windows*10 	<p>D415 Features</p> <ul style="list-style-type: none"> • Intel® RealSense™ Vision Processor D4 for real-time depth • Up to 1280x720 resolution active stereo depth • FOV (HxVxD): 69°x42°x77° • Dual rolling shutter sensors for up to 90FPS deoth strem • Full HD RGB camera calibrated and synchronized to depth data • Cross-platform open source Intel® RealSense™ SDK2.0 <p>D435 Features</p> <ul style="list-style-type: none"> • Intel® RealSense™ Vision Processor D4 for real-time depth • Up to 1280x720 resolution active stereo depth • FOV (HxVxD): 91°x65°x100° • Dual global shutter sensors for up to 90FPS deoth strem • Full HD RGB camera calibrated and synchronized to depth data • Cross-platform open source Intel® RealSense™ SDK2.0
--	---



2 Introduction

2.1 Disclaimer

The current version of document is a guide to give an understanding of product details of Intel® RealSense™ Camera Depth Camera D415/D435. Specifications detail are subject to change until revision 0.9. Post revision 0.9 will be to address bugs and issues. Please contact your Intel representative to be notified of changes to this document and future revision releases.

2.2 Purpose and Scope of this Document

This document captures the specifications for the Intel® RealSense™ Depth Camera D415/D435. This document provides a project team with the information necessary to understand and to use Intel® RealSense™ Depth Camera D415/D435.

2.3 Terminology

Term	Description
Stereo Camera Baseline	The distance between the center of the left and right imagers in a stereo camera
Depth	Depth video streams are like color video streams except each pixel has a value representing the distance away from the camera instead of color information
FOV	Field Of View (FOV) describes the angular extent of a given scene that is imaged by a camera. A camera's FOV can be measured horizontally, vertically, or diagonally
Vision Processor	Intel® RealSense™ Vision Processor D4 The Intel RealSense Vision Processor D4 is a purpose-built ASIC for computing real time depth and accelerating computer vision, at significantly faster speeds and fraction of the power compared to host based compute.
Depth Module	Intel® RealSense™ Depth Module The Depth Module incorporates the left and right imagers with the IR projector and RGB color sensor
Host System	Computer or SOC connected to Intel® RealSense™ Depth camera
IR Projector	This refers to the source of infrared (IR) light used for illuminating a scene, object, or person to collect depth data.
Imagers	RealSense Depth camera system uses a pair of camera sensors referred as imagers to calculate depth. They are identical cameras configured with identical settings.

Term	Description
Image Signal Processor (ISP)	Image processing functions to enhance color image quality
Left imager	From the perspective of the stereo camera looking out at the world, the left imager is on the left side of the camera module. Thus, when the user is facing the RealSense Depth camera, the left imager is actually on the right side of the camera module.
Lens	This refers to the optical component of an imager in the RealSense Depth module. Its purpose is to focus the incoming light rays onto the CMOS chip in the imager.
System On Chip (SOC)	Integrated circuit (IC) that integrates all components of a computer
Stereo module	This refers to a stiffened module containing at least two imagers. The distance between the imagers, which is referred to as the baseline or intraocular spacing, is typically in the range of 20 mm to 70 mm.
Stereo camera	This refers to a pair of imagers looking at the same subject from slightly different perspectives. The difference in the perspectives is used to generate a depth map by calculating a numeric value for the distance from the imagers to every point in the scene.
SKU	Stock Keeping Unit (SKU) is a unique identifier for distinct products. It is often used in the scope of naming different versions of a device
TBD	To Be Determined. In the context of this document, information will be available in a later revision.

2.4 Overview

Intel® RealSense™ Depth Camera D400-series is a long range depth camera that outputs depth video stream. In addition to depth video stream, it can provide color, and infrared video streams.

2.4.1 Intel® RealSense™ Depth Camera D400-Series SKUs

Table below describes main components that make up the different product SKUs

Table 2-1. Product SKU Descriptions

Component	Subcomponent	Intel® RealSense™ Depth Camera D415	Intel® RealSense™ Depth Camera D435
Intel® RealSense™ Vision Processor D4	-	√	√
	Standard Stereo Imagers	√	X

Component	Subcomponent	Intel® RealSense™ Depth Camera D415	Intel® RealSense™ Depth Camera D435
Intel® RealSense™ Depth Module	Wide Stereo Imagers	X	√
	Standard Infrared Projector	√	X
	Wide Infrared Projector	X	√
	RGB color sensor	√	√

Table 2-2. Intel® RealSense™ Depth Camera D415 Mechanical Dimensions

Dimension	Min	Nominal	Max	Unit
Width		99		mm
Height		23		mm
Depth		20		mm
Mass		72		gr

Table 2-3. Intel® RealSense™ Depth Camera D435 Mechanical Dimensions

Dimension	Min	Nominal	Max	Unit
Width		90		mm
Height		25		mm
Depth		25		mm
Mass		72		gr

Figure 2-1. Intel® RealSense™ Depth Camera D415



Figure 2-2. Intel® RealSense™ Depth Camera D435



2.5 Stereo Vision Depth Technology Overview

The Intel® RealSense™ depth camera D400 series uses stereo vision to calculate depth. The stereo vision implementation consists of a left imager, right imager, and an optional infrared projector. The infrared projector projects non-visible static IR pattern to improve depth accuracy in scenes with low texture. The left and right imagers capture the scene and sends imager data to the depth imaging processor, which calculates depth values for each pixel in the image by correlating points on the left image to the right image and via shift between a point on the Left image and the Right image. The depth pixel values are processed to generate a depth frame. Subsequent depth frames create a depth video stream.

Figure 2-3. Active Infrared (IR) Stereo Vision Technology

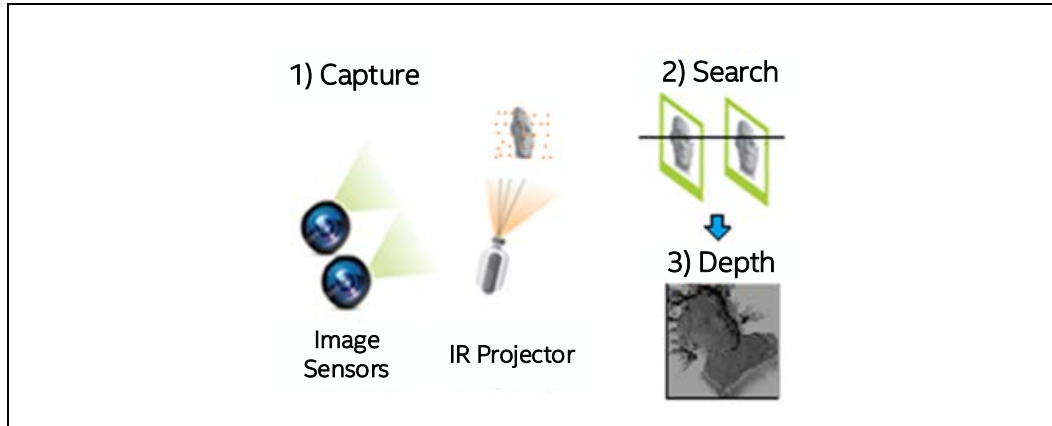

The depth pixel value is a measurement from the parallel plane of the imagers and not the absolute range as illustrated.

Figure 2-4. Depth Measurement (Z) Versus Range (R)

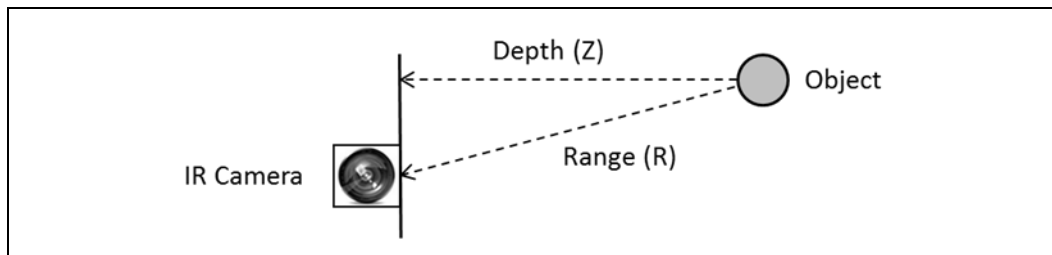

2.6 D400-Series Camera Block Diagram

The D400-Series Cameras has 2 main components, Vision Processor, and Depth Module. The Vision Processor referred as Intel® RealSense™ Vision Processor D4 is connecting to the host processor through USB 3.0. The Depth Module incorporates the left and right imagers with the IR projector and RGB color sensor. The RGB color sensor data is sent to the Vision Processor via the color Image Signal Processor (ISP).

Figure 2-5. D415/D435 System Block Diagram

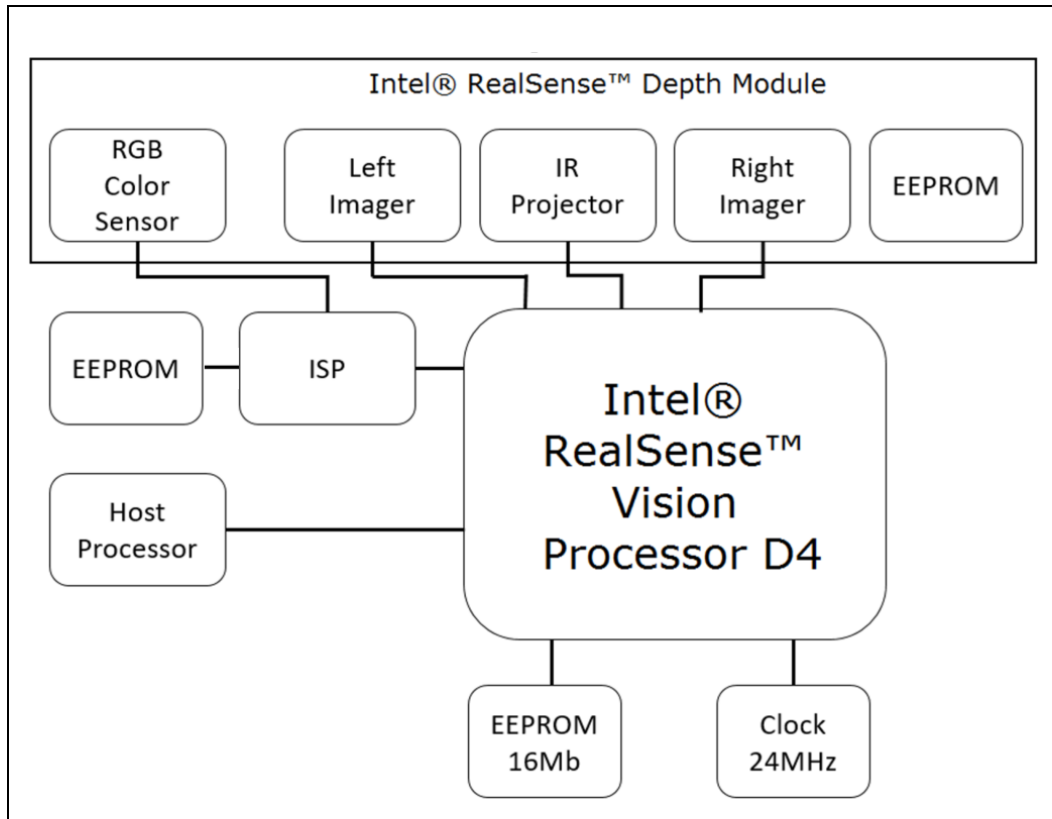

2.7 Depth Module

The Depth Module components are described in Table 2-4. The Depth camera printed circuit board and components are encapsulated in a common metal stiffener.

Table 2-4. Depth Module

Component	Description
Left & Right Imagers	2 1080p image sensors
Infrared (IR) Projector	Class 1 laser compliant
Color Camera	1080p RGB image sensor
Stereo Camera Connector	50 pin connector plug
Privacy LED	Indicator when stereo module is streaming data
Stiffener	Reinforcement housing to keep imagers aligned
Label	Manufacture and product identifier information
Other Components	Laser Driver, EEPROM, Voltage Regulators, etc.

Figure 2-6. Depth Module in D415 (Intel® RealSense™ Depth Module D415)

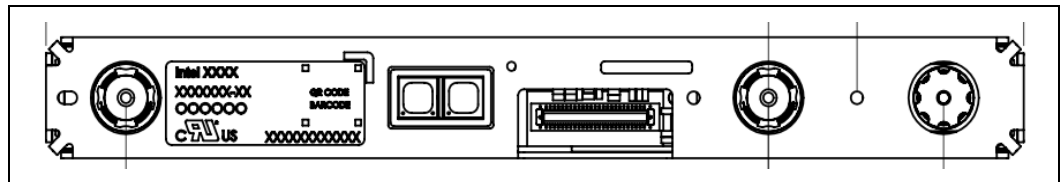

Figure 2-7. Depth Module in D435 (Intel® RealSense™ Depth Module D430)

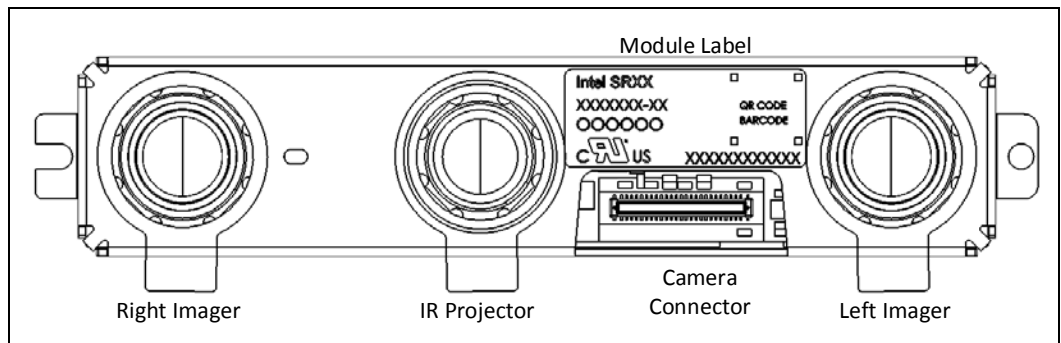

Table 2-5. Depth Module SKU Properties

D400-Series Depth Cameras	Intel® RealSense™ Depth Camera D415	Intel® RealSense™ Depth Camera D435
Depth module	Intel® RealSense™ Depth Module D415	Intel® RealSense™ Depth Module D435
Baseline	55mm	50mm
Left/Right Imagers Type	Standard	Wide
Left/Right Imagers FOV (degrees)	H: 69.4 / V: 42.5 / D: 77	H: 91.2 / V: 65.5 / D: 100.6
IR Projector	Standard	Wide
IR Projector FOV	H: 80 / V: 55 / D: 89.3	H: 100.4 / V: 69 / D: 110.4
Color Sensor	OV2740	OV2740
Color Camera FOV	H: 69.4 / V: 42.5 / D: 77	H: 69.4 / V: 42.5 / D: 77
Depth Module Dimensions (mm)	X=83.7mm Y=10mm Z=4.7mm	X=70.7mm Y=14mm Z=10.53mm

H – Horizontal FOV, V – Vertical FOV, D – Diagonal FOV, X – Length, Y – Breadth, Z – Thickness

2.7.1 Left and Right Imagers

The Depth Module has two camera sensors referred here as stereo imagers, they are identical parts and are configured with identical settings. The imagers are labeled “left” and “right” from the perspective of the camera module looking outward. The stereo imager pairs are referred as Standard and Wide based on imager field of view.

Table 2-6. Standard Left and Right Imager Properties (for D415)

Parameter	Camera Sensor Properties
Image Sensor	OV2740
Active Pixels	1920 × 1080
Sensor Aspect Ratio	16:9
Format	10-bit RAW
F Number	f/2.0
Focal Length	1.88mm
Filter Type	None
Focus	Fixed
Shutter Type	Rolling Shutter
Signal Interface	MIPI CSI-2, 2X Lanes
Horizontal Field of View	69.4°
Vertical Field of View	42.5°
Diagonal Field of View	77°
Distortion	<= 1.5%

Table 2-7. Wide Left and Right Imager Properties (for D435)

Parameter	Camera Sensor Properties
Image Sensor	OV9282
Active Pixels	1280 X 800
Sensor Aspect Ratio	8:5
Format	10-bit RAW
F Number	f/2.0
Focal Length	1.93mm
Filter Type	None
Focus	Fixed
Shutter Type	Global Shutter
Signal Interface	MIPI CSI-2, 2X Lanes
Horizontal Field of View	91.2°
Vertical Field of View	65.5°
Diagonal Field of View	100.6°
Distortion	<= 1.5%

2.7.2 Infrared Projector

The infrared projector improves the ability of the Depth module to determine depth by projecting a static infrared pattern on the scene to increase texture on low texture scenes. The infrared projector meets class 1 laser safety under normal operation. The power delivery and laser safety circuits are on the Depth Module.

Table 2-8. Standard Infrared Projector Parameters

Parameter	Properties
Projector	Infrared
Pattern Type	Static
Illuminating Component	Vertical-cavity surface-emitting laser (VCSEL) + Optics
Laser Controller	PWM
Optical Power	350mW average, 440mW peak
Laser Wavelength	850nm \pm 10 nm nominal @ 20°C
Laser Compliance	Class 1, IEC 60825-1:2007 Edition 2, IEC 60825-1:2014 Edition 3
Horizontal Field of Projection	80°
Vertical Field of Projection	55°
Diagonal Field of Projection	89.3°

Table 2-9. Wide Infrared Projector Parameters

Parameter	Properties
Projector	Infrared
Pattern Type	Static
Illuminating Component	Vertical-cavity surface-emitting laser (VCSEL) + optics
Laser Controller	PWM
Optical Power	350mW average, 4.25W peak
Laser Wavelength	850nm \pm 10 nm nominal @ 20°C
Laser Compliance	Class 1, IEC 60825-1:2007 Edition 2, IEC 60825-1:2014 Edition 3
Horizontal Field of Projection	100.4°
Vertical Field of Projection	69°
Diagonal Field of Projection	110.4°

2.7.3 Color Camera

The color camera on the depth module in addition to color image provides texture information. Usages for the texture information include overlay on a depth image to create a color point cloud and overlay on a 3D model for reconstruction.

Table 2-10. Color Sensor Properties

Parameter	Camera Sensor Properties
Image Sensor	OV2740
ISP	Discrete
Active Pixels	1920 X 1080
Sensor Aspect Ratio	16:9
Format	10-bit RAW RGB
F Number	f/2.0
Focal Length	1.93mm
Filter Type	IR Cut Filter
Focus	Fixed
Shutter Type	Rolling Shutter
Signal Interface	MIPI CSI-2, 1 Lane
Vertical Field of View	69.4°
Horizontal Field of View	42.5°
Diagonal Field of View	77°
Distortion	<=1.5%

2.8 Color Image Signal Processor (ISP)

The RGB sensor on the depth module sends color data to discrete Image Signal Processor (ISP) for image adjustments, image scaling and processing functions to help compensate for inherent inaccuracy in lens and sensor in providing a better image quality. The processed color image is sent to the Intel® RealSense™ Vision Processor D4.

Table 2-11. ISP Properties

Parameter	ISP Properties
ISP Part Number on Intel® RealSense™ Vision Processor D4 Card	RTS5845
1M-bit Serial Flash for ISP	Winbond* W25X10CL or equivalent
Interface To Intel® RealSense™ Vision Processor D4	MIPI CSI-2, 2X Lanes
Interface To RGB Sensor	MIPI CSI-2, 1X Lane

2.9 Intel® RealSense™ Vision Processor D4 Card

The Intel® RealSense™ Vision Processor D4 Card enables an easy and quick option for system integrators to integrate Intel® RealSense™ Vision Processor D4 into a system.

Table 2-12. Intel® RealSense™ Vision Processor D4 Card Components

Components	Description
Intel® RealSense™ Vision Processor D4	The Intel RealSense Vision Processor D4 is a purpose-built ASIC for computing real time depth and accelerating computer vision, at significantly faster speeds and fraction of the power compared to host based compute.
16Mb Serial Flash	Intel® RealSense™ Vision Processor D4 firmware storage
24MHz Crystal	Clock source for Vision Processor
Realtek* ISP with external serial flash	Color image signal processor
Camera Receptacle	50 pin receptacle for connection to Depth Module
Tracking Module Receptacle	50 pin connector receptacle for connection to Tracking Module and/or RGB sensor
USB Type-C	USB peripheral connector for connection to Host USB3.0 port
External Sensor Sync Connector	Interface to external sensor interrupts/sync signals
Voltage Regulators	DC to DC converters powering Intel® RealSense™ Vision Processor D4 Card, Depth Module and Tracking Module
Mounting holes	Intel® RealSense™ Vision Processor D4 Card secure mounting

Figure 2-8. Intel® RealSense™ Vision Processor D4 Card

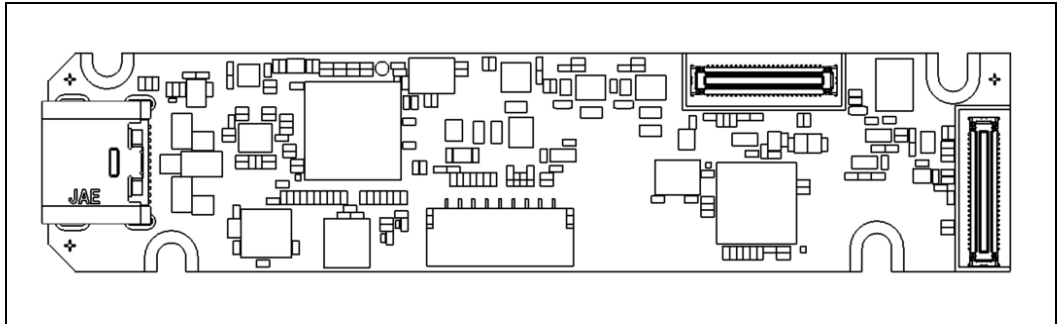

2.9.1 Power Requirements

The Depth Camera is powered through VBUS power of the USB connector. The Intel® RealSense™ Vision Processor D4 Card in turn power sources the Depth Module.

Table 2-13. Power Requirements

Parameter		Min	Nom	Max	Unit
VCC	Supply Voltage	+/-5%	5 V		V
ICC	Supply Current			700	mA

2.10 D400-Series Depth Cameras Thermals

Table 2-14. Max Skin Temperature

D400-Series Depth Cameras	Max Skin Temperature (25 °C Ambiance at Open Environment)
D415	43 °C (estimated)
D435	44 °C

2.11 Storage and Operating Conditions

Table 2-15. Storage and Operating Conditions

Condition	Description	Min	Max	Unit
Storage (Ambient), Not Operating	Temperature	-40	70	°C
	Humidity	Temperature/ RH: 40°C / 90%		
Operating ⁽¹⁾ (Ambient)	Temperature	0	35	°C

NOTE: Component case temperature limits must be met for all operating temperatures.

§ §

3 Functional Specification

3.1 Depth Camera

Intel® RealSense™ Depth Camera D400 series provides high quality depth data to a host system. The depth data is generated with stereo vision technology that is optionally assisted by an infrared laser projector. Intel® RealSense™ Depth Camera D400 series has the ability to synchronize with Color camera streams.

Table 3-1. Intel® RealSense™ Depth Camera D400 Series Image Formats

Format	Resolution	Frame Rate	Comment
Z [16 bits]	1280x720	6,15,30	Depth Only Mode
	848x480	6,15,30,60,90	
	640x480	6,15,30,60,90	
	640x360	6,15,30,60,90	
	480x270	6,15,30,60,90	
	424x240	6,15,30,60,90	
Y8 [8 bits] L_UYVY [16 bits] RY8_LY8 [16 bits]	1280x720	6,15,30	Illumination Mode Only
	848x480	6,15,30,60,90	
	640x480	6,15,30,60,90	
	640x360	6,15,30,60,90	
	480x270	6,15,30,60,90	
	424x240	6,15,30,60,90	
YUY2	1920x1080	6,15,30	Color channel
	1280x720	6,15,30,60	
	960x540	6,15,30,60	
	848x480	6,15,30,60	
	640x480	6,15,30,60	
	640x360	6,15,30,60	
	424x240	6,15,30,60	
	320x240	6,15,30,60	
	320x180	6,15,30,60	
Calibration [24 bits]	1920x1080	25,15	Intel® RealSense™ Camera D415
	960x540	30,15	Intel® RealSense™ Camera D435
	1280x800	30,15	
	640x400	30,15	
RY8_LY8 [16 bits]	1920x1080	25,15	Dynamic Calibration for D415

Format	Resolution	Frame Rate	Comment
RY8_LY8 [16 bits]	1280x800	30,15	Dynamic Calibration for D435

NOTE: Depth/RGB are mapped as separated interfaces. The two interfaces work independently from each other (Virtual channel in MIPI and End Point in USB).

3.2 Depth Camera Functions

Intel® RealSense™ Depth Camera D400 series exposes the following Depth image settings.

Table 3-2. Depth Camera Controls

Control	Description	Min	Max	Default
Manual Exposure ⁽¹⁾ (ms)	Control sensor exposure period (D415)	1	166	10
Manual Exposure ⁽¹⁾ (ms)	Control sensor exposure period (D435)	1	166	2
Manual gain ⁽¹⁾ (Gain 1.0 = 16)	Control sensor digital gain.	16	248	16
Laser Power (on/off) (On = 1)	Power to IR Projector	0	1	1
Manual Laser Power (mW)	Laser Power setting (30mW steps)	0	360	240
Auto Exposure Mode (Enable = 1)	Auto Exposure Mode. When Auto Exposure is enabled, Exposure and Gain are set based on the environment condition	0	1	1
Auto Exposure ROI	Perform Auto Exposure on a selected ROI	T-0 L-0 B-1 R-1	T-719 L-1279 B-720 R-1280	T-0 L-0 B-1 R-1
Preset	Set Controls parameters based on Camera Usage			

NOTES:

- ⁽¹⁾Not supported in Auto Exposure Mode
- T - Top, L – Left, B - Bottom, R – Right

3.3 Color Camera Functions

Table 3-3. RGB (Integrated) Exposed Controls

Control	Description	Min	Max	Default
Auto-Exposure Mode	Automatically sets the exposure time and gain for the frame.			
Auto-Exposure Priority	The setting for the attribute of the addressed Auto-Exposure Priority control.			
Manual Exposure Time	Sets the absolute exposure time when auto-exposure is disabled.			
Backlight Compensation	Sets a weighting amount based on brightness to the frame.			
Brightness	Sets the amount of brightness applied when auto-exposure is enabled.			
Contrast	Sets the amount of contrast based on the brightness of the scene.			
Gain	Sets the amount of gain applied to the frame if auto-exposure is disabled.			
Power Line Frequency	Specified based on the local power line frequency for flicker avoidance.			
Hue	Sets the amount of hue adjustment applied to the frame.			
Saturation	Sets the amount of saturation adjustment applied to the frame.			
Sharpness	Sets the amount of sharpening adjustment applied to the frame.			
Gamma	Sets amount of gamma correction applied to the frame.			
White Balance Temperature Control	Sets the white balance when AWB is disabled.			
White Balance Temperature Auto (AWB)	Enables or disables the AWB algorithm.			

§ §

4 *Software Package*

4.1 Intel® RealSense™ Software Development Kit 2.0

Intel® RealSense™ Software Development Kit 2.0 (SDK 2.0) also known as LibRealSense, is cross-platform and open source. The SDK contains tools, code examples and multiple languages wrappers to extract data from the Intel® RealSense™ depth cameras.

Intel® RealSense SDK 2.0 supports the D415 and D435 Camera.

The SDK is comprised of the following main SW components:

Tools directory:

- **Intel® RealSense™ Viewer** – A GUI based application for a quick evaluation of the RealSense camera.
- **Depth Quality Test tool for Intel® RealSense™ Camera** – A GUI based application for testing the camera's depth quality

Debug tools: please use these tools for getting logs or further information for debugging your application.

Examples directory: Simple applications that demonstrate how to easily use the SDK APIs to build applications.

Wrappers directory: Wrappers supporting common programming languages and environments.

The Intel® RealSense™ SDK 2.0 can be found on GitHub:
<https://github.com/IntelRealSense/librealsense>



5 Firmware

The firmware contains the operation instructions. Upon runtime, Intel® RealSense™ Depth Camera D400 series loads the firmware and programs the component registers. If the Intel® RealSense™ Depth Camera D400 series is configured for update or recovery, the unlocked R/W region of the firmware can be changed.

5.1 Firmware Update

During a firmware update, the Device Firmware Update tool for Intel® RealSense™ technology will issue a device firmware update command to the RealSense D400 series Depth Camera. The RealSense D400 series Depth Camera will then reset into firmware update mode. The Device Firmware Update tool for Intel® RealSense™ technology uses a single binary file to maintain the firmware image. The Device Firmware Update tool for Intel® RealSense™ technology compares the firmware version installed on the camera to the firmware version file to be updated. Based on the comparison, the Device Firmware Update tool for Intel® RealSense™ technology will downgrade, upgrade, or skip if the versions match.

The device firmware update tool and firmware binary will be located at the <https://downloadcenter.intel.com/>

5.1.1 Update Limits

The firmware update engine does not allow infinite update cycles between older and current versions of firmware. The engine will establish a baseline version of firmware based on the latest firmware version installed. The engine will allow a return to a previous version or baseline version of firmware up to 20 times. After the 20th update, the engine will only allow an update to a firmware revision higher than the baseline version.

5.2 Recovery

A read only boot sector is built into firmware which enables basic operation regardless of the integrity of the operation instructions region. This ensures the imaging system can function in the case of firmware not be written properly. When a firmware recovery is required, the Device Firmware Update tool for Intel® RealSense™ technology will communicate with the recovery driver to set the DFU pin low and reset the imaging system in recovery mode.

Firmware Recovery can also be externally triggered by having controllable interrupt connected to the Intel® RealSense™ Vision Processor D4 DFU (Device Firmware Update) pin.

The firmware recovery sequence will be triggered by the firmware client utility. This client utility will communicate through ACPI _DSM to trigger the controllable interrupt (GPIO) at the appropriate times. The firmware recovery requires an ACPI _DSM interface to control the interrupt GPIO in configuring to firmware recovery state. The _DSM methods and BIOS use the Write to GPIO functions to set the controllable interrupt.



6 Calibration Support

The Intel® RealSense™ Depth Camera D415/D435 can be connected to PC to retrieve and write camera calibration parameters via the host system.

6.1 Dynamic Calibration Tool

The name of the tool is: Intel® RealSense™ Dynamic Calibrator, please find it on <https://downloadcenter.intel.com/>

There are two types of dynamic calibrations that are supported by the tool:

1. Targeted Dynamic Calibration (Depth Scale Calibration)
2. Target-less Dynamic Calibration (Rectification Calibration)

Refer to the user guide of Intel® RealSense™ Dynamic Calibrator for further information.

§ §

7 Regulatory Compliance

7.1 System Laser Compliance

The Intel® RealSense™ Depth Camera D400-series certification is transferable to the system and no system recertification is required. However, the following statements and labels must be included in the user manual of the end product

7.1.1 Certification Statement

This product is classified as a Class 1 Laser Product under the EN/IEC 60825-1, Edition 3 (2014) internationally and IEC60825-1, Edition 2 (2007) in the US.

This product complies with US FDA performance standards under 21 CFR 1040.10 for laser products except for deviations pursuant to Laser Notice No. 50 dated June 24, 2007.

7.1.2 Explanatory Label

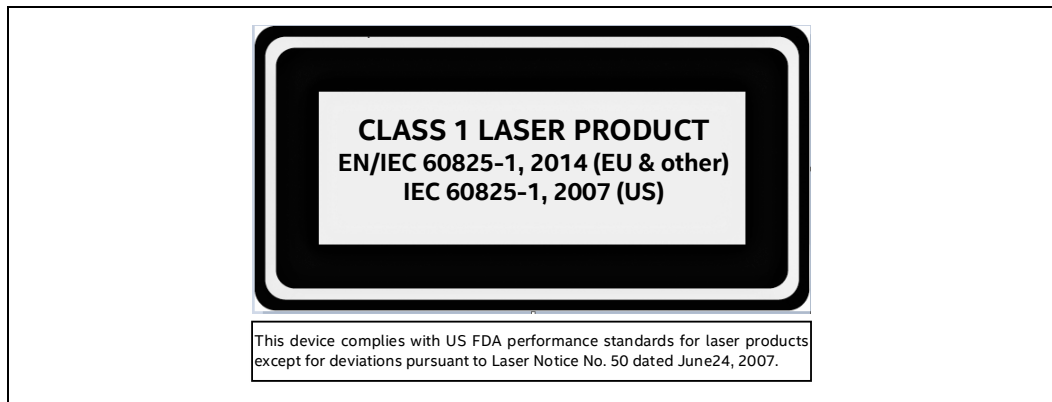

7.1.3 Cautionary Statements



System integrators should refer to their respective regulatory and compliance owner to finalize regulatory requirements for a specific geography.



CAUTION - Use of controls or adjustments or performance of procedures other than those specified herein may result in hazardous radiation exposure.

7.1.4 Safety and Handling Instructions:



- Do not power on the product if any external damage was observed.
- Do not attempt to open any portion of this laser product. There are no user serviceable parts.
- Invisible laser radiation when opened. Avoid direct exposure to beam.
- Do not modify or service the product in any way. Modification or service of the hardware might cause the emissions to exceed the Class 1 level.
- No magnifying optical elements, such as eye loupes and magnifiers, are allowed.
- Do not try to update camera firmware that is not officially released for specific camera module SKU and revision.

7.1.5 Manufacturer’s Information

- Manufactured by Intel Corporation
- 2200 Mission College Blvd., Santa Clara, CA 95054 USA

7.1.6 US FDA Accession Number

Camera	US FDA Accession Numbers
Intel® RealSense™ Depth Camera D415	1420260-006
Intel® RealSense™ Depth Camera D435	1420260-007

This accession number should be entered into Box B.1 of the Food and Drug Administration (FDA) 2877 Declaration for Imported Electronic Products Subject to Radiation Control Standards.

7.2 Ecology Compliance

China RoHS Declaration

产品中有毒有害物质的名称及含量
Hazardous Substances Table

部件名称 Component Name	有毒有害物质或元素 Hazardous Substance					
	铅 Pb	汞 Hg	镉 Cd	六价铬 Cr (VI)	多溴联苯 PBB	多溴二苯醚 PBDE
相机 Camera	X	○	○	○	○	○
印刷电路板组件 Printed Board Assemblies	X	○	○	○	○	○
三角架 Tripod	○	○	○	○	○	○
电缆 Cable	○	○	○	○	○	○
<p>○：表示该有毒有害物质在该部件所有均质材料中的含量均在GB/T 26572标准规定的限量要求以下。</p> <p>○：Indicates that this hazardous substance contained in all homogeneous materials of such component is within the limits specified in GB/T 26572.</p> <p>×：表示该有毒有害物质至少在该部件的某一均质材料中的含量超出GB/T 26572标准规定的限量要求。</p> <p>×：Indicates that the content of such hazardous substance in at least a homogeneous material of such component exceeds the limits specified in GB/T 26572.</p> <p>对销售之日的所售产品, 本表显示我公司供应链的电子信息产品可能包含这些物质。注意：在所售产品中可能会也可能不会含有所有所列的部件。</p> <p>This table shows where these substances may be found in the supply chain of our electronic information products, as of the date of sale of the enclosed product. Note that some of the component types listed above may or may not be a part of the enclosed product.</p> <p>除非另外特别的标注, 此标志为针对所涉及产品的环保使用期限标志。某些可更换的零部件可能会有一个不同的环保使用期限(例如, 电池单元模块)。</p> <p>此环保使用期限只适用于产品在产品手册中所规定的条件下工作。</p>						



The Environment-Friendly Use Period (EFUP) for all enclosed products and their parts are per the symbol shown here, unless otherwise marked. Certain field-replaceable parts may have a different EFUP (for example, battery modules) number. The Environment-Friendly Use Period is valid only when the product is operated under the conditions defined in the product manual.



"In the EU, this symbol means that this product must not be disposed of with household waste. It is your responsibility to bring it to a designated collection point for the recycling of waste electrical and electronic equipment. For more information, please contact your local waste collection center or your point of purchase of this product."

§ §

8 Mechanical Drawings

Figure 8-1. Intel® RealSense™ Depth Camera D415

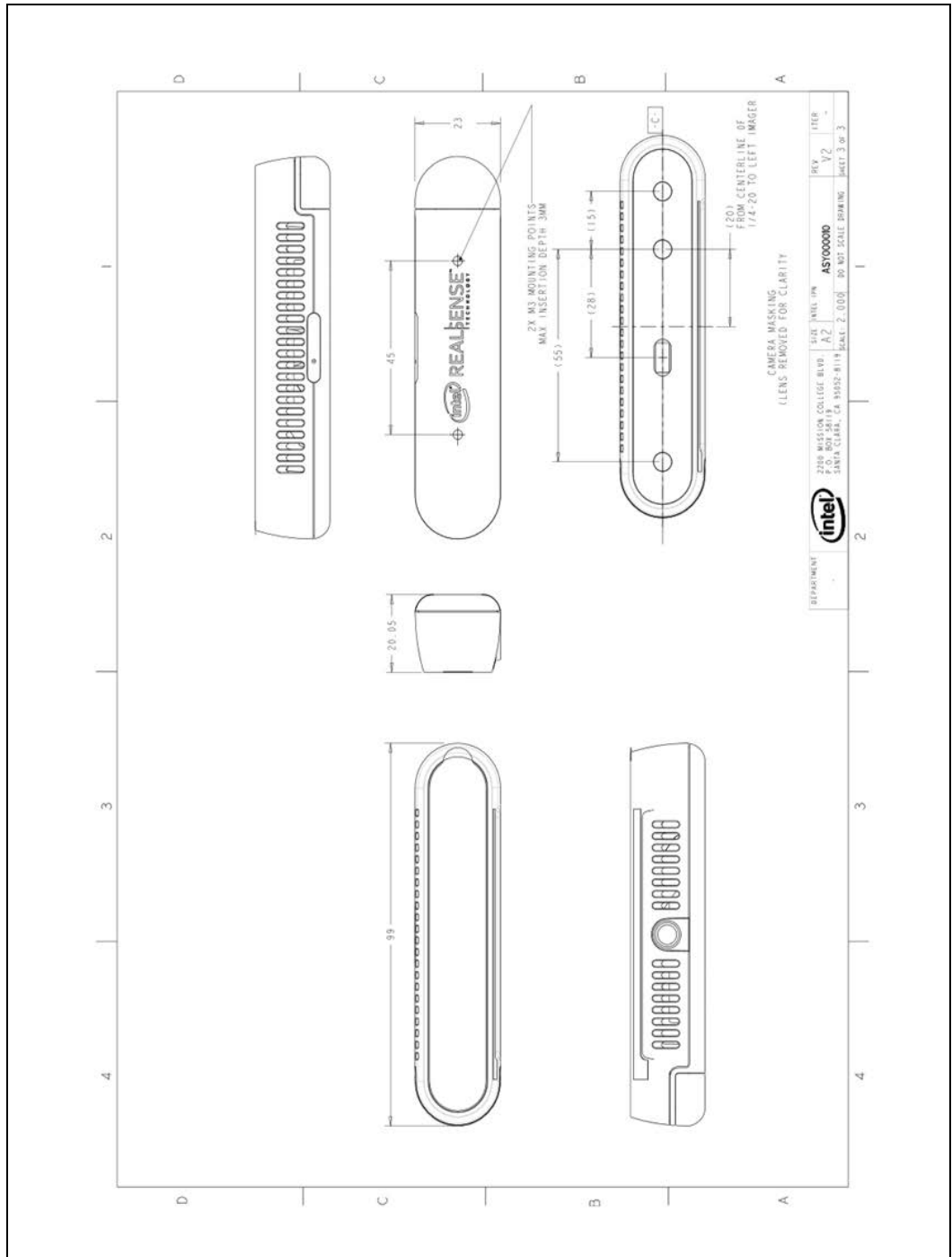
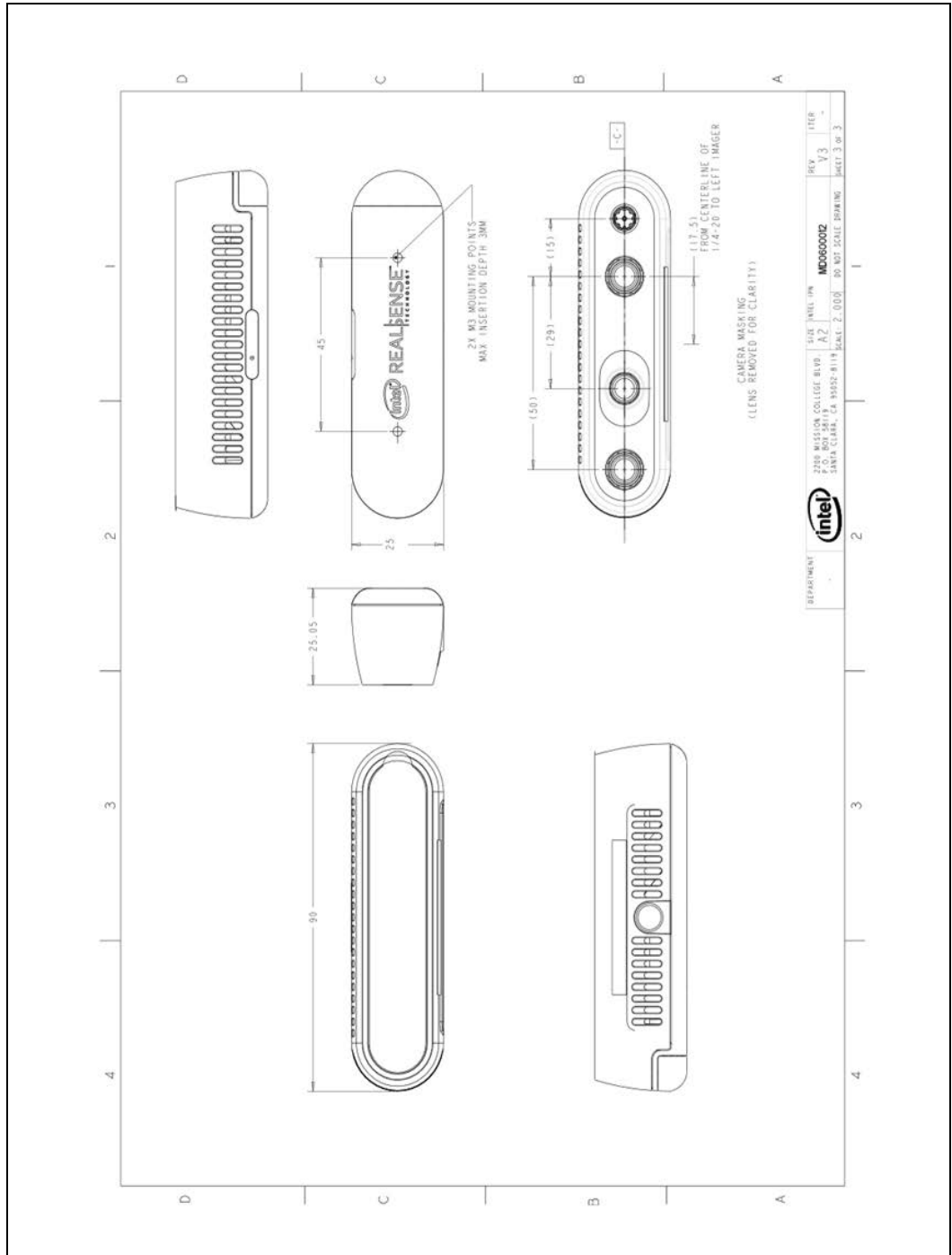

Figure 8-2. Intel® RealSense™ Depth Camera D435



§ §