

TOSHIBA

TOSHIBA Barcode Printer

B-EX4T2 SERIES



Owner's Manual
Mode d'emploi
Bedienungsanleitung
Manual de instrucciones
Gebruikershandleiding
Manuale Utente
Manual do Utilizador

TOSHIBA

TOSHIBA Barcode Printer

B-EX4T2 SERIES

Owner's Manual



CE Compliance (for EU only)

This product complies with the requirements of EMC and Low Voltage Directives including their amendments.

VORSICHT:

- *Schallemission: unter 70dB (A) nach DIN 45635 (oder ISO 7779)*
- *Die für das Gerät Vorgesehene Steckdose muß in der Nähe des Gerätes und leicht zugänglich sein.*

Centronics is a registered trademark of Centronics Data Computer Corp.
Microsoft is a registered trademark of Microsoft Corporation.
Windows is a trademark of Microsoft Corporation.

This equipment has been tested and found to comply with the limits for a Class A digital device, pursuant to Part 15 of the FCC Rules. These limits are designed to provide reasonable protection against harmful interference when the equipment is operated in a commercial environment. This equipment generates, uses, and can radiate radio frequency energy and, if not installed and set in accordance with the instruction manual, may cause harmful interference to radio communications. Operations of this equipment in a residential area is likely to cause harmful interference in which case the user will be required to correct the interference at his own expense.

(for USA only)

Changes or modifications not expressly approved by the manufacturer for compliance could void the user's authority to operate the equipment.

"This Class A digital apparatus meets all requirements of the Canadian Interference-Causing Equipment Regulations."

"Cet appareil numérique de la classe A respecte toutes les exigences du Règlement sur le matériel brouilleur du Canada."

(for CANADA only)



N258

IP20

Waste Recycling information for users:

Following information is only for EU-member states:

The use of the crossed-out wheeled bin symbol indicates that this product may not be treated as general household waste.

By ensuring this product is disposed of correctly you will help prevent potential negative consequences for the environment and human health, which could otherwise be caused by inappropriate waste handling of this product. For more detailed information about the take-back and recycling of this product, please contact your supplier where you purchased the product.



Precautions for the handling of Wireless Communication Devices

Wireless LAN Module: SD-Link 11g

RFID Module: TEC-RFID-EU1 (B-EX700-RFID-H1-QM-R)

For Europe

This device was tested and certified by Notified Body.

Hereby, Toshiba TEC Corporation declares that this device is in compliance with the essential requirements and other relevant provisions of Directive 1999/5/EC.

This equipment uses the radio frequency band which has not been standardised throughout the EU and EFTA countries. It can be used in the following countries.

Austria, Belgium, Bulgaria, Cyprus, Czech Republic, Denmark, Estonia, Finland, France, Hungary, Germany, Greece, Ireland, Italy, Latvia, Lithuania, Luxembourg, Malta, Netherlands, Poland, Portugal, Romania, Slovakia, Slovenia, Spain, Sweden, United Kingdom, Norway, Liechtenstein, Iceland, Switzerland

For USA

This device complies with Part 15 of the FCC Rules.

Operation is subject to the following two conditions:

- (1) This device may not cause harmful interference, and
- (2) This device must accept any interference received, including interference that may cause undesired operation.

Changes or modification not expressly approved by manufacturer for compliance could void the user's authority to operate the equipment.

For Canada

Operation is subject to the following two conditions:

- (1) This device may not cause interference, and
- (2) This device must accept any interference, including interference that may cause undesired operation of the device.

For Taiwan

Caution

根據低功率電波輻射性電機管理辦法

For safety

Do not operate this product in locations where its use may be prohibited. For example, in an aeroplane or hospital. If you are unsure whether operation is permitted, please refer to and follow the airline company or medical institution guidelines.

Otherwise, flight instrument or medical equipment may be affected, causing a serious accident.

This product may affect the operation of some implanted cardiac pacemakers and other medically implanted equipment. Pacemaker patients should be aware that the use of this product in close proximity to a pacemaker might cause the device to malfunction.

If you have any reason to suspect that interference is taking place, immediately turn off the product and contact your TOSHIBA TEC sales agent.

Do not disassemble, modify, or repair the product as doing so may cause injury.

Modification is also against the Laws and Regulations for Radio Equipment. Please ask your TOSHIBA TEC sales agent for repair.

Safety Summary

Personal safety in handling or maintaining the equipment is extremely important. Warnings and Cautions necessary for safe handling are included in this manual. All warnings and cautions contained in this manual should be read and understood before handling or maintaining the equipment.

Do not attempt to effect repairs or modifications to this equipment. If a fault occurs that cannot be rectified using the procedures described in this manual, turn off the power, unplug the machine, and then contact your authorised TOSHIBA TEC representative for assistance.

Meanings of Each Symbol



This symbol indicates warning items (including cautions). Specific warning contents are drawn inside the Δ symbol. (The symbol on the left indicates a general caution.)



This symbol indicates prohibited actions (prohibited items). Specific prohibited contents are drawn inside or near the $\text{\textcircled{X}}$ symbol. (The symbol on the left indicates “no disassembling”.)



This symbol indicates actions which must be performed. Specific instructions are drawn inside or near the \bullet symbol. (The symbol on the left indicates “disconnect the power cord plug from the outlet”.)



WARNING

This indicates that there is the risk of **death** or **serious injury** if the machine is improperly handled contrary to this indication.



Use only specified AC voltage.

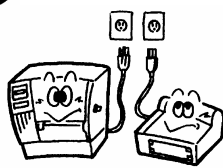

Do not use voltages other than the AC voltage specified on the rating plate, as this may cause **fire** or **electric shock**.



Prohibited

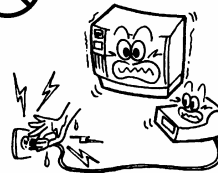

Do not plug in or unplug the power cord with wet hands as this may cause **electric shock**.



Prohibited



If the machine shares the same electrical outlet, with any other appliance that consumes a large amount of power, the voltage will fluctuate widely each time these appliances operate. Be sure to provide an exclusive outlet for the machine as this may cause **fire** or **electric shock**.



Prohibited



Do not place metal objects or water-filled containers (flower vases, flower pots or mugs etc) on top of the machine. If metal objects or spilled liquids enter the machine, this may cause **fire** or **electric shock**.



Prohibited

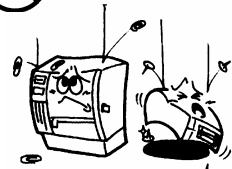

Do not insert or drop metal, flammable or other foreign objects into the machine through ventilation slits, as this may cause **fire** or **electric shock**.



Prohibited



Do not scratch, damage or modify the power cords. Do not place heavy objects on, pull on, or excessively bend the power cords, as this may cause **fire** or **electrical shock**.



Disconnect the plug.













If the machine is dropped or the cabinet is damaged, turn off the power switch and disconnect the power cord plug from the outlet, and then contact your authorised TOSHIBA TEC representative for assistance. Continued use of a damaged machine may cause **fire** or **electric shock**.

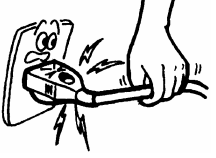

Disconnect the plug.

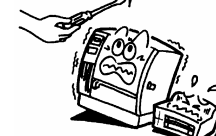

Continued use of the machine in an abnormal condition (the machine is producing smoke or a strange smell) may cause **fire** or **electric shock**. In these cases, immediately turn off the power switch and disconnect the power cord plug from the outlet. Then, contact your authorised TOSHIBA TEC representative for assistance.

| | | | |
|--|---|--|--|
|  <p>Disconnect the plug.</p>  | <p>If foreign objects (metal fragments, water, liquids) enter the machine, turn off the power switch and disconnect the power cord plug from the outlet, and then contact your authorised TOSHIBA TEC representative for assistance. Continued use of the machine in that condition may cause fire or electric shock.</p> |  <p>Disconnect the plug.</p>  | <p>When unplugging the power cords, be sure to hold and pull on the plug. Pulling on the cord may cut or expose the internal wires and cause fire or electric shock.</p> |
|  <p>Connect a grounding wire.</p>  | <p>Ensure that the equipment is properly grounded. Extension cables should also be grounded. Fire or electric shock could occur on improperly grounded equipment.</p> |  <p>No disassembling.</p>  | <p>Do not remove covers, repair or modify the machine yourself. Contact your TOSHIBA TEC representative for assistance. You may be injured by high voltage, very hot parts or sharp edges inside the machine.</p> |
|  <p>Prohibited</p>  | <p>Do not use a spray cleaner containing flammable gas for cleaning this product, as this may cause a fire.</p> |  <p>Prohibited</p>  | <p>Care must be taken not to injure yourself with the printer paper cutter.</p> |



CAUTION

This indicates that there is the risk of personal **injury** or **damage** to objects if the machine is improperly handled contrary to this indication.

Precautions

The following precautions will help to ensure that this machine will continue to function correctly.

- Try to avoid locations that have the following adverse conditions:
 - * Temperatures out of the specification
 - * Direct sunlight
 - * High humidity
 - * Shared power source
 - * Excessive vibration
 - * Dust/Gas
- The cover should be cleaned by wiping with a dry cloth or a cloth slightly dampened with a mild detergent solution. **NEVER USE THINNER OR ANY OTHER VOLATILE SOLVENT** on the plastic covers.
- **USE ONLY TOSHIBA TEC SPECIFIED** paper and ribbons.
- **DO NOT STORE** the paper or ribbons where they might be exposed to direct sunlight, high temperatures, high humidity, dust, or gas.
- Ensure the printer is operated on a level surface.
- Any data stored in the memory of the printer could be lost during a printer fault.
- Try to avoid using this equipment on the same power supply as high voltage equipment or equipment likely to cause mains interference.
- Unplug the machine whenever you are working inside it or cleaning it.
- Keep your work environment static free.
- Do not place heavy objects on top of the machine, as these items may become unbalanced and fall causing **injury**.
- Do not block the ventilation slits of the machine, as this will cause heat to build up inside the machine and may cause **fire**.
- Do not lean against the machine. It may fall on you and could cause **injury**.
- Unplug the machine when it is not used for a long period of time.
- Place the machine on a stable and level surface.

Request Regarding Maintenance

- Utilise our maintenance services.
After purchasing the machine, contact your authorised TOSHIBA TEC representative for assistance once a year to have the inside of the machine cleaned. Dust will build up inside the machines and may cause a **fire** or a **malfunction**. Cleaning is particularly effective before humid rainy seasons.
- Our preventive maintenance service performs periodic checks and other work required to maintain the quality and performance of the machine.
For details, please consult your authorised TOSHIBA TEC representative.
- Do not expose the machine to insecticides or other volatile solvents. This may cause the cabinet, or other parts, to deteriorate and may cause the paint to peel.

Notification (for Turkey)

EEE Yönetmeliğine Uygundur

TABLE OF CONTENTS

| | Page |
|---|--------------|
| 1. PRODUCT OVERVIEW | E1- 1 |
| 1.1 Introduction..... | E1- 1 |
| 1.2 Features | E1- 1 |
| 1.3 Unpacking..... | E1- 1 |
| 1.4 Accessories | E1- 2 |
| 1.5 Appearance | E1- 3 |
| 1.5.1 Dimensions | E1- 3 |
| 1.5.2 Front View..... | E1- 3 |
| 1.5.3 Rear View | E1- 3 |
| 1.5.4 Operation Panel..... | E1- 4 |
| 1.5.5 Interior..... | E1- 4 |
| 1.6 Options | E1- 5 |
| 2. PRINTER SETUP | E2- 1 |
| 2.1 Installation | E2- 2 |
| 2.2 Connecting the Power Cord..... | E2- 3 |
| 2.3 Loading Supplies | E2- 4 |
| 2.3.1 Loading the Media | E2- 5 |
| 2.3.2 Loading the Ribbon..... | E2-10 |
| 2.4 Connecting the Cables to Your Printer..... | E2-12 |
| 2.5 Turning the Printer ON/OFF..... | E2-13 |
| 2.5.1 Turning ON the Printer..... | E2-13 |
| 2.5.2 Turning OFF the Printer..... | E2-13 |
| 2.6 Printer Setting..... | E2-14 |
| 2.6.1 User System Mode | E2-15 |
| 2.6.2 Parameter Setting..... | E2-16 |
| 2.6.3 Enabling LAN/WLAN | E2-24 |
| 2.6.4 Basic Program Setting..... | E2-24 |
| 2.6.5 Enabling Z-Mode..... | E2-25 |
| 2.6.6 Automatic Calibration..... | E2-26 |
| 2.6.7 Dump Mode Setting | E2-27 |
| 2.6.8 Logging | E2-29 |
| 2.6.9 System Mode..... | E2-30 |
| 2.6.10 Interface Setting..... | E2-31 |
| 2.6.11 Real Time Clock (RTC)..... | E2-38 |
| 2.6.12 Copying Data to/from USB Memory | E2-39 |
| 2.7 Installing the Printer Drivers | E2-40 |
| 2.7.1 Introduction | E2-40 |
| 2.7.2 General Description | E2-40 |
| 2.7.3 Installing the Printer Driver | E2-40 |
| 2.7.4 Preparation for installation..... | E2-41 |
| 2.7.5 Installation under Windows2000/XP/Server2003..... | E2-43 |
| 2.7.6 Installation under WindowsVista/Server2008/7/Server2008R2 | E2-48 |
| 2.7.7 Installation under Windows2000 (USB with Plug & Play enabled) | E2-51 |
| 2.7.8 Installation under WindowsXP/Server2003 (USB with Plug & Play enabled)..... | E2-53 |
| 2.7.9 Installation under Windows Vista/Server2008/7/Server2008R2 (USB with Plug & Play enabled)..... | E2-54 |
| 2.7.10 Uninstalling the Printer Driver | E2-55 |
| 2.8 Print Test | E2-58 |

| | | |
|---|--|--------------|
| 2.9 | Position and Print Tone Fine Adjustment | E2-60 |
| 2.9.1 | Fine Adjustment..... | E2-60 |
| 2.10 | Threshold Setting..... | E2-67 |
| 2.11 | Sensor Setting | E2-69 |
| 3. | ONLINE MODE | E3- 1 |
| 3.1 | Key Functions..... | E3- 1 |
| 3.2 | LCD | E3- 2 |
| 3.2 | Operation Example..... | E3- 3 |
| 4. | MAINTENANCE | E4- 1 |
| 4.1 | Cleaning | E4- 1 |
| 4.1.1 | Print Head/Platen/Sensors | E4- 1 |
| 4.1.2 | Covers and Panels | E4- 2 |
| 4.1.3 | Optional Cutter Module..... | E4- 3 |
| 5. | TROUBLESHOOTING | E5- 1 |
| 5.1 | Error Messages | E5- 1 |
| 5.2 | Possible Problems..... | E5- 4 |
| 5.3 | Removing Jammed Media | E5- 5 |
| 6. | PRINTER SPECIFICATIONS | E6- 1 |
| 7. | SUPPLY SPECIFICATIONS..... | E7- 1 |
| 7.1 | Media..... | E7- 1 |
| 7.1.1 | Media Type | E7- 1 |
| 7.1.2 | Detection Area of the Transmissive Sensor..... | E7- 3 |
| 7.1.3 | Detection Area of the Reflective Sensor | E7- 4 |
| 7.1.4 | Effective Print Area | E7- 4 |
| 7.1.5 | RFID Tags..... | E7- 6 |
| 7.2 | Ribbon | E7- 8 |
| 7.3 | Recommended Media and Ribbon Types | E7- 10 |
| 7.4 | Care/Handling of Media and Ribbon | E7- 17 |
| APPENDIX 1 MESSAGES AND LEDS | | EA1-1 |
| APPENDIX 2 INTERFACE | | EA2-1 |
| APPENDIX 3 PRINT SAMPLES..... | | EA3-1 |
| APPENDIX 4 GLOSSARIES | | EA4-1 |

WARNING!

This is a Class A product. In a domestic environment this product may cause radio interference in which case the user may be required to take adequate measures.

CAUTION!

- This manual may not be copied in whole or in part without prior written permission of TOSHIBA TEC.*
- The contents of this manual may be changed without notification.*
- Please refer to your local Authorised Service representative with regard to any queries you may have in this manual.*

1. PRODUCT OVERVIEW

1.1 Introduction

Thank you for choosing the TOSHIBA B-EX4T2 series bar code printer. This Owner's Manual contains from general set-up through to how to confirm the printer operation using a test print, and should be read carefully to help gain maximum performance and life from your printer. For most queries please refer to this manual and keep it safe for future reference. Please contact your TOSHIBA TEC representative for further information concerning this manual.

1.2 Features

This printer has the following features:

- The print head block can be opened providing smooth loading of media and ribbon.
- Various types of media can be used as the media sensors can be moved from the centre to the left edge of the media.
- Web based functions such as remote maintenance and other advanced network features are available.
- Superior hardware, including the specially developed 8 dots/mm (203 dots/inch) thermal print head which will allow very clear print at a printing speed of 3, 6, 10, or 12 inches/sec. and 3, 5, 8, 10, or 12 inches/sec. with 11.8 dots/mm (300 dots/inch) thermal head. 23.6 dots/mm (600 dpi) thermal print head which will allow very clear print at a printing speed of 2, 3, 4, 5, or 6 inches/sec.

1.3 Unpacking

NOTES:

1. Check for damage or scratches on the printer. However, please note that TOSHIBA TEC shall have no liability for any damage of any kind sustained during transportation of the product.
2. Keep the cartons and internal packing for future transportation of the printer.

| B-EX4T TYPE 2 | | |
|---------------|--------|--------|
| 203dpi | 300dpi | 600dpi |
| 3ips | 3ips | 2ips |
| 6ips | 5ips | 3ips |
| 10ips | 8ips | 4ips |
| 12ips | 10ips | 5ips |
| | 12ips | 6ips |
| | | |

- Besides the optional Cutter Module, there is also an optional Peel off Module, RS-232C I/F card, Centronics I/F card, Expansion I/O Card, Wireless LAN I/F card, the RTC/USB host I/F card, HF band RFID mount kit and Narrow width platen kit.

Unpack the printer as per the Unpacking Instructions supplied with the printer.

1.4 Accessories

When unpacking the printer, please make sure all the following accessories are supplied with the printer.

- Power cord

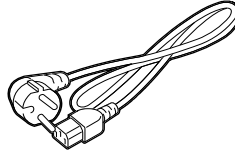

- Safety precautions

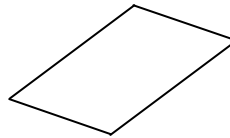

- Quick installation manual

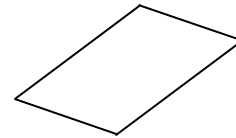

- CD-ROM(1pc.)



1.5 Appearance

The names of the parts or units introduced in this section are used in the following chapters.

1.5.1 Dimensions

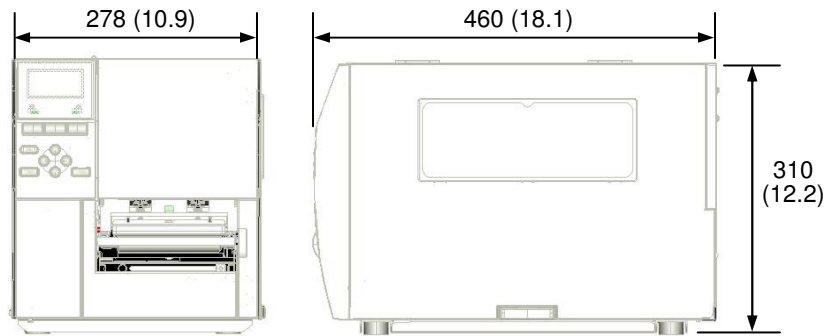

Dimensions in mm (inches)

1.5.2 Front View



1.5.3 Rear View

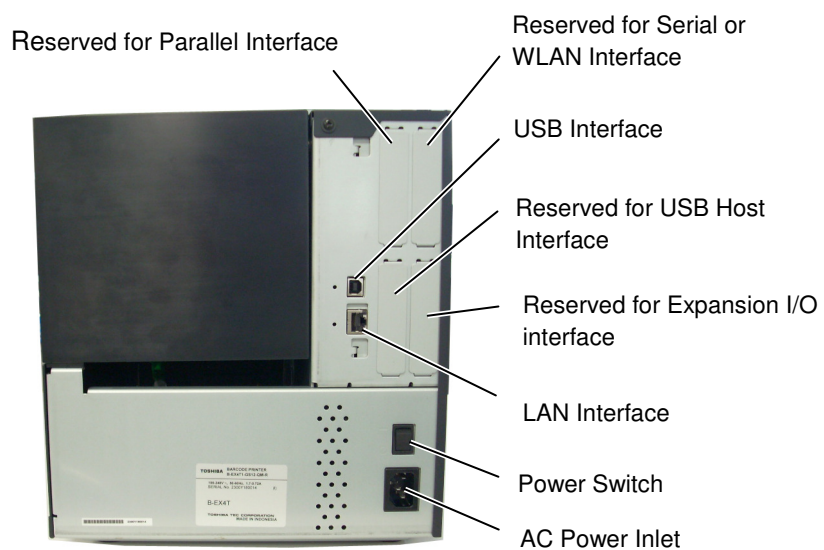

1.5.4 Operation Panel

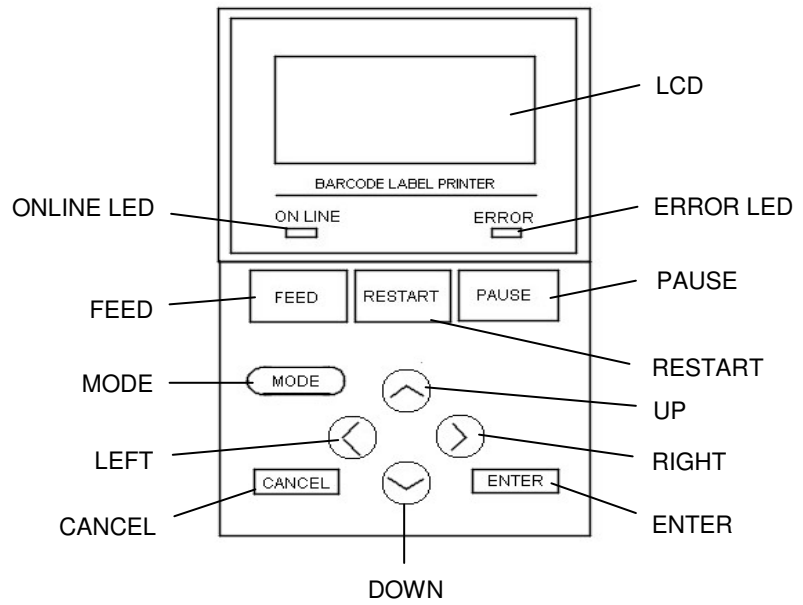

Please see **Section 3** for further information about the Operation Panel.

1.5.5 Interior

1.6 Options

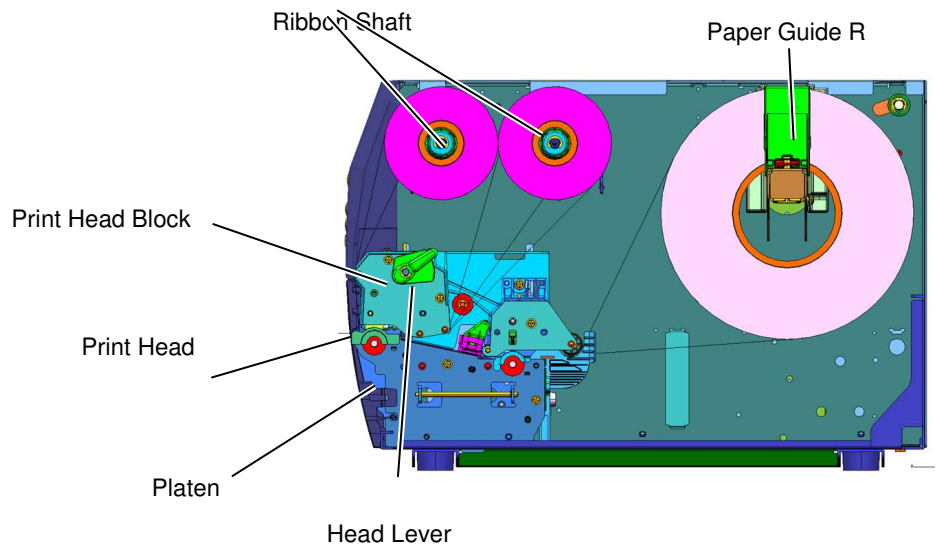

| Option Name | Type | Description |
|-------------------------------|----------------------|--|
| Disc cutter module | B-EX204-QM-R | Disc cutter Each time media is cut, the media feed is stopped. |
| Strip module | B-EX904-H-QM-R | This allows use of on-demand (peel-off) operation or to take-up labels and backing paper together when using the rewind guide plate. To purchase the strip module, please inquire with your local distributor. |
| RFID module mount kit | B-EX700-RFID-H1-QM-R | This kit is to mount Tagsys HF band RFID module and antenna. |
| 203-dpi print head | B-EX704-TPH2-QM-R | This print head enables a conversion of a 300dpi print head of the B-EX4T2-TS12 model into 203dpi print head. |
| 300-dpi print head | B-EX704-TPH3-QM-R | This print head enables a conversion of a 203dpi print head of the B-EX4T2-GS12 model into 300dpi print head. |
| 600-dpi print head | B-EX704-TPH6-QM-R | Only with B-EX4T2-HS12 Model |
| RTC & USB host interface card | B-EX700-RTC-QM-R | This card holds the current time: year, month, day, hour, minute, second and provides a USB host interface. |
| Expansion I/O interface card | B-EX700-IO-QM-R | Installing this card in the printer allows connection to an external device with the exclusive interface. |
| Parallel interface card | B-EX700-CEN-QM-R | Installing this card provides a Centronics interface port. |
| Serial interface card | B-EX700-RS-QM-R | Installing this card provides an RS-232C interface port. |
| Wireless LAN interface card | B-EX700-WLAN-QM-R | Installing this card provides Wireless LAN communication. |
| | | |

NOTE:

To purchase the optional kits, please contact the nearest authorised TOSHIBA TEC representative or TOSHIBA TEC Head Quarters.

2. PRINTER SETUP

This section outlines the procedures to setup your printer prior to its operation. The section includes precautions, loading media and ribbon, connecting cables, setting the operating environment of the printer and performing an online print test.

| Setup Flow | Procedure | Reference |
|---|---|---|
| Installation | After referring to the Safety Precautions in this manual, install the printer in a safe and stable location. | 2.1 Installation |
| Connecting the power cord | Connect a power cord to the power inlet of the printer, then to an AC outlet. | 2.2 Connecting the Power Cord |
| Loading the media | Load a label stock or tag stock. | 2.3.1 Loading the Media |
| Media sensor position alignment | Adjust the position of feed gap sensor or black mark sensor according to the media being used. | 2.3.1 Loading the Media |
| Loading the ribbon | If using thermal transfer media then load the ribbon. | 2.3.2 Loading the Ribbon |
| Connecting to a host computer | Connect the printer to a host computer or network. | 2.4 Connecting the Cables to Your Printer |
| Turning the power ON | Turn on the printer power. | 2.5 Turning the Printer ON/OFF |
| Printer setting | Set the printer parameters in the system mode. | 2.6 Printer Setting |
| Installing the printer driver | If necessary, install the printer driver on your host computer. | 2.7 Installing the Printer Drivers |
| Print test | Make a print test from your operating environment and check the print result. | 2.8 Print Test |
| Position and Print Tone Fine adjustment | If necessary, fine adjust the print start position, cut/strip position, print tone, etc. | 2.9 Position and Print Tone Fine Adjustment |
| Automatic threshold setting | If the print start position cannot be detected properly when pre-printed label are used, set the threshold automatically. | 2.10 Threshold Setting |
| Manual threshold setting | If the print start position cannot be detected properly even after automatic threshold setting is performed manually set the threshold. | 2.10 Threshold Setting |

2.1 Installation

To insure the best operating environment and to assure the safety of the operator and equipment, please observe the following precautions.

- Operate the printer on a stable, level surface in a location free from excessive humidity, high temperature, dust, vibration and direct sunlight.
- Keep your work environment static free. Static discharge can cause damage to delicate internal components.
- Make sure the printer is connected to a clean source of AC power and no other high-voltage devices, that may cause line noise interference, are connected to the same mains.
- Assure that the printer is connected to the AC mains with a three-prong power cable that has the proper ground (earth) connection.
- Do not operate the printer with the cover open. Be careful not to allow fingers or articles of clothing to get caught in any of the moving parts, especially the optional cutter mechanism.
- For best results, and longer printer life, use only TOSHIBA TEC recommended media and ribbons.
- Store the media and ribbons in accordance with their specifications.
- This printer mechanism contains high-voltage components; therefore you should never remove any of the covers of the machine as you may receive an electrical shock. Additionally, the printer contains many delicate components that may be damaged if accessed by unauthorised personnel.
- Clean the outside of the printer with a clean, dry cloth or a clean cloth slightly dampened with a mild detergent solution.
- Use caution when cleaning the thermal print head as it will become very hot while printing. Wait until it has had time to cool before cleaning. Use only the TOSHIBA TEC recommended print head cleaner to clean the print head.
- Do not turn off the printer power or remove the power plug while the printer is printing or while the ON LINE lamp is flashing.

2.2 Connecting the Power Cord

CAUTION!

1. Make sure that the printer Power Switch is turned to the OFF (O) position before connecting the Power Cord to prevent possible electric shock or damage to the printer.
2. Connect the Power Cord to a supply outlet with a properly grounded (earthed) connection.

1. Make sure that the printer Power Switch is in the OFF (O) position. Connect the Power Cord to the printer as shown in the figure below.

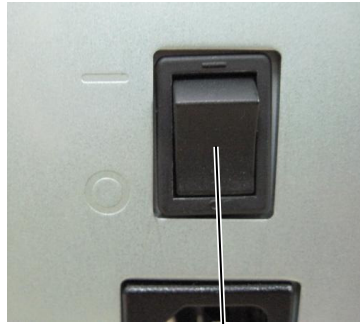

Power Switch

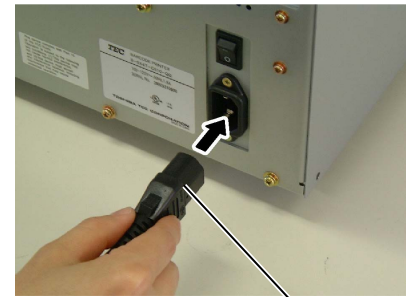

Power Cord

2. Plug the other end of the Power Cord into a grounded outlet as shown in the figure below.

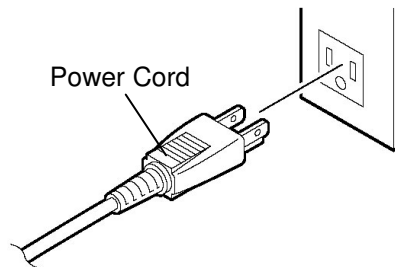

[Example of US Type]

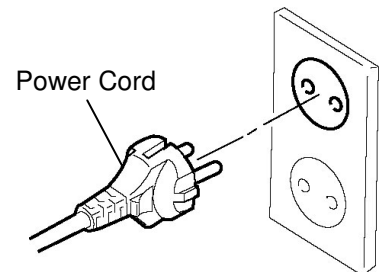

[Example of EU Type]

2.3 Loading Supplies

WARNING!

1. Do not touch any moving parts. To reduce the risk of fingers, jewellery, clothing, etc., being drawn into the moving parts, be sure to load the media once the printer has stopped moving completely.
2. The Print Head becomes hot immediately after printing, allow it to cool before loading the media.
3. To avoid injury, be careful not to trap your fingers while opening or closing the cover.

CAUTION!

1. Be careful not to touch the Print Head Elements when lifting the Print Head Block. This may cause missing dots due to static electricity or other print quality problems.
2. When loading or replacing the media or ribbon, be careful not to damage the print head with hard objects like watches or rings.



Care must be taken not to allow the metal or glass part of a watch to touch the print head edge.



Care must be taken not to allow a metal object like a ring to touch the print head edge.

Since the print head element can be easily damaged by shock, please treat it carefully and do not hit it with hard objects .

2.3.1 Loading the Media

The following procedure shows the steps to properly load the media into the printer so that it feeds straight through the printer.

The printer prints both labels and tags.

1. Open the Top Cover.
2. Turn the Head Lever to the **FREE** position and release the Ribbon Shaft Holder Plate.
3. Open the Print Head Block.

NOTES:

1. When the Head Lever is turned to **FREE** position, the Print Head can be raised.
2. To enable printing the Head Lever must be set to the **LABEL / TAG** position. (This ensures that the Print Head is closed.)
There are two head pressure levels in the **LABEL / TAG** position. Set the Head Lever depending on the media type:
Position **LABEL**: Labels
Position **TAG**: Tags
However, proper position may differ depending on media. For details, refer to your TOSHIBA TEC authorised service representative.

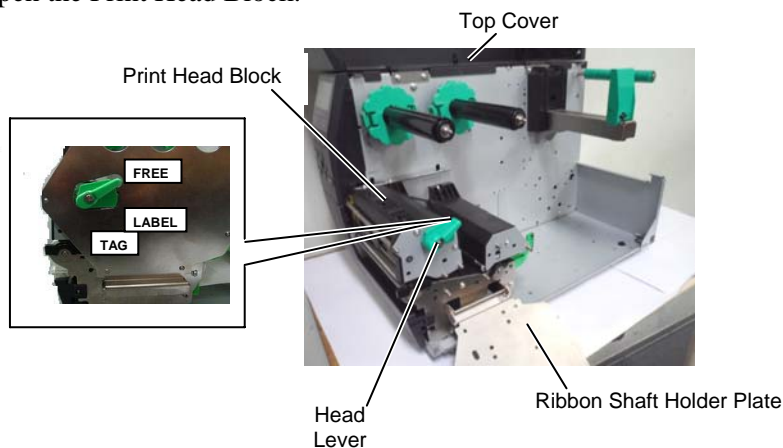

4. Move the Paper guide R to the rightmost position or shift the guide to the horizontal position.

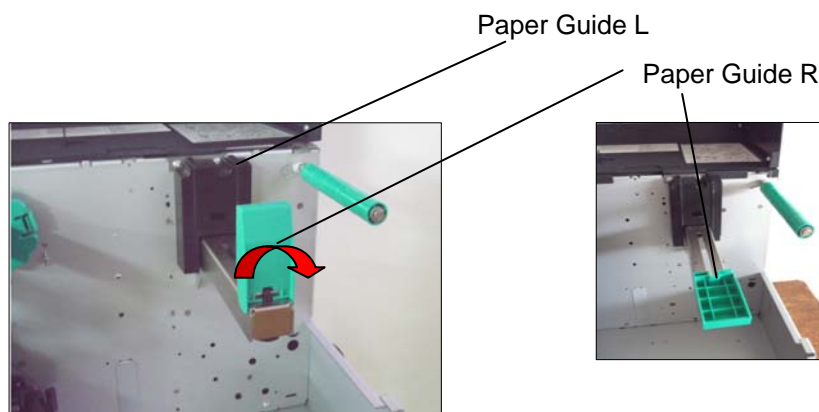

5. Put the media on the Paper Holder.
6. Pass the media around the Paper Holder, and then pull the media towards the front of the printer.
7. Push the Paper Guide against the media until the media is held firmly in place. To lock the Media, shift the Paper Guide R to vertical position

2.3.1 Loading the Media (Cont.)

NOTE:
Do not over-tighten the Locking Ring of the Supply Holder.

In the case of labels rolled with the print side facing inside.



In the case of labels rolled with the print side facing outside.

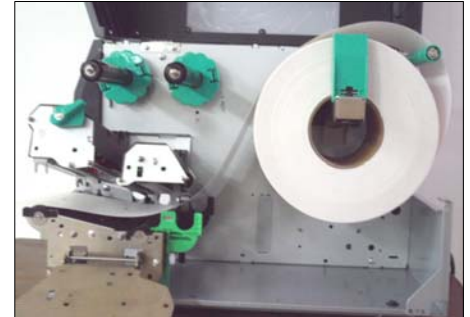

8. Place the media between the Media Guides and adjust them to the media width. Once in the correct position tighten the Locking Screw.
9. Check that the media's path through the printer is straight. The media should be to the left side of the print head

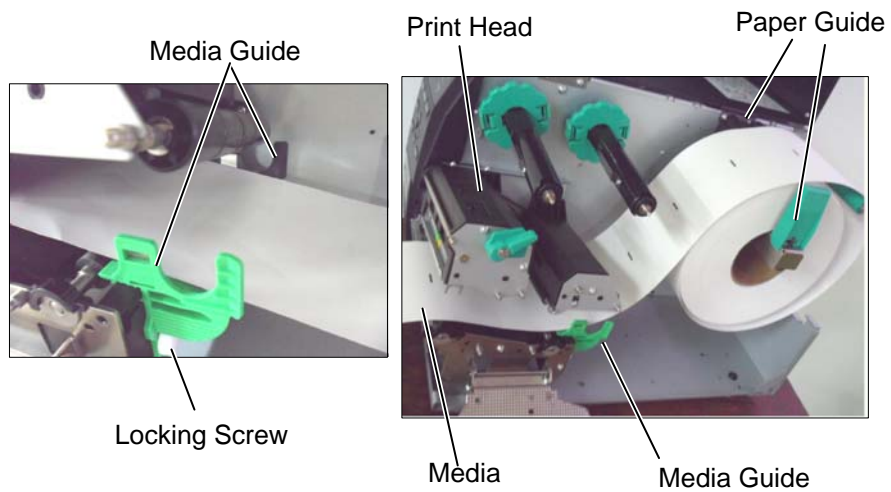

2.3.1 Loading the Media (Cont.)

10. Lower the Print Head Block.
11. Once the media is loaded it may be necessary to set the Media Sensors used to detect the start position for label or tag.

Setting the Feed Gap Sensor position

- (1) Manually move the Media Sensor so that the Feed Gap Sensor is positioned at the centre of the labels. (● indicates the position of the Feed Gap Sensor).

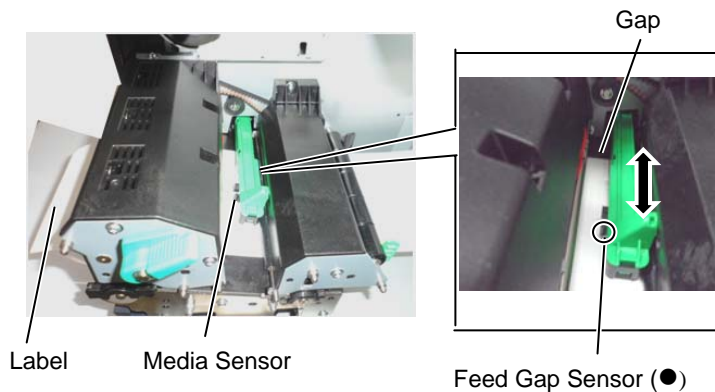

NOTE:

Be sure to set the black mark sensor to detect the centre of the black mark, otherwise a paper jam or no paper error may occur.

Setting the Black Mark Sensor position

- (1) Pull about 500 mm of media out of the front of the printer, turn the media back on itself and feed it under the Print Head past the sensor so that the black mark can be seen from above.
- (2) Manually move the Media Sensor so that the Black Mark Sensor is in line with the centre of the black mark on the media. (■ indicates the position of the Black Mark Sensor).

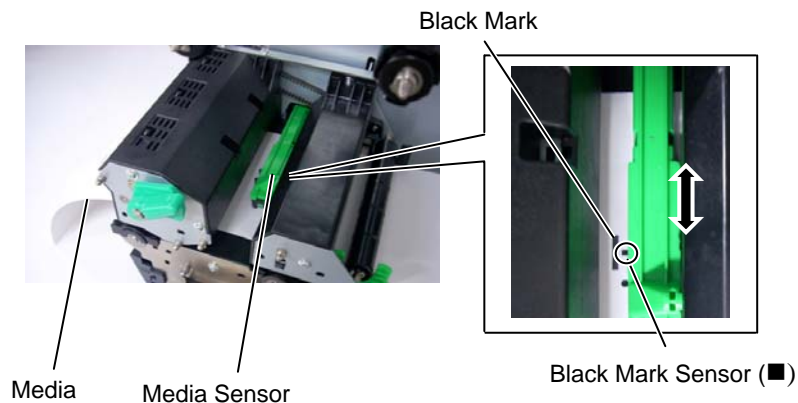

2.3.1 Loading the Media (Cont.)

- 12. Batch mode
In batch mode, the media is continuously printed until the number of labels/tags specified in the issue command has been printed.

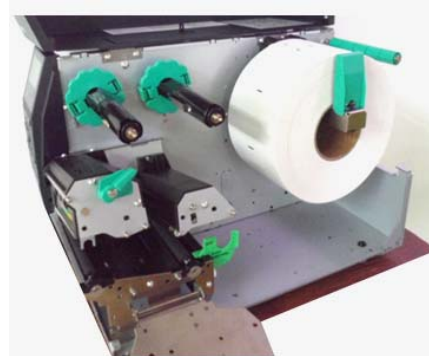

- 13. Loading with peel off module
When the optional Strip Module is fitted, the label is automatically removed from the backing paper at the Strip Plate as each label is printed.

NOTES:

1. Be sure to set the Selection Switch to **STANDARD/PEEL OFF** position.
2. The backing paper is easier to feed back to the Take-Up Spool if the Front Plate is removed.
3. Fit the Take-Up Clip so that the longer side of the clip is fitted into the shallow groove in the Take-Up Spool.
4. The backing paper can be wound directly onto the Take-up Spool or a paper core.

- (1) Remove enough labels from the leading edge of the media to leave 500mm of backing paper free.
- (2) Insert the backing paper under the Strip Plate.
- (3) Wind the backing paper onto the Take-up Spool and fix it in position with the Take-up Clip. (Wind the paper counter-clockwise around the spool.)
- (4) Rotate the Take-up Spool counter-clockwise a few times to remove any slack in the backing paper.
- (5) Set the Selection Switch mounted on the Rewinder Assembly to **STANDARD/PEEL OFF** position.

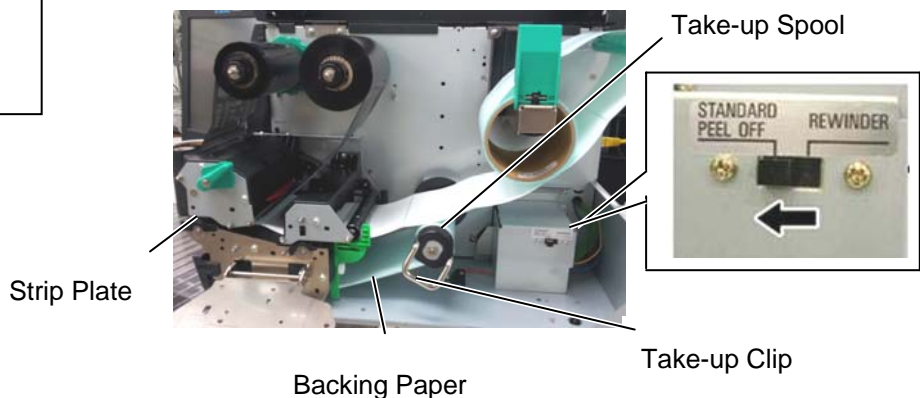

2.3.1 Loading the Media (Cont.)

WARNING!

The cutter is sharp, so care must be taken not to injure yourself when handling the cutter.

CAUTION!

- 1. Be sure to cut the backing paper of the label. Cutting labels will cause the glue to stick to the cutter which may affect the cutter quality and shorten the cutter life.*
- 2. Use of tag paper when the thickness exceeds the specified value may affect the cutter life.*

14. Loading with cutter

When the optional Cutter Module is fitted, the media is automatically cut. A disc cutter is available as option. Insert the leading edge of the media into the cutter until it comes out the Media Outlet of the Cutter Module.

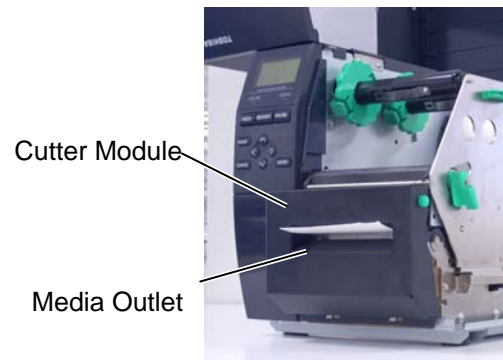

2.3.2 Loading the Ribbon

NOTES:

1. When attaching the ribbon stoppers, make sure that the pinchers face into the printer
2. Be sure to remove any slack in the ribbon before printing. Printing with a wrinkled ribbon will reduce the print quality.
3. The Ribbon Sensor is mounted on the rear of the Print Head Block to detect a ribbon end. When a ribbon end is detected a "NO RIBBON" message will appear on the display and the ERROR LED will illuminate.

There are two types of media available for printing on: thermal transfer and direct thermal (which has a chemically treated surface). DO NOT LOAD a ribbon when using direct thermal media.

1. Grasp the tabs on the top and bottom of the Ribbon Stoppers and move the Ribbon Stoppers back to the end of the Ribbon Shaft.

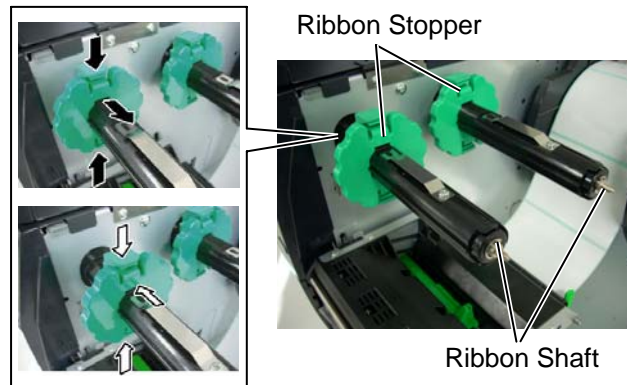

2. Leaving plenty of slack between the ribbon spools, place the ribbon onto the Ribbon Shafts as shown below. There are 2 possible ways to load the ribbon.

Ribbon Shaft

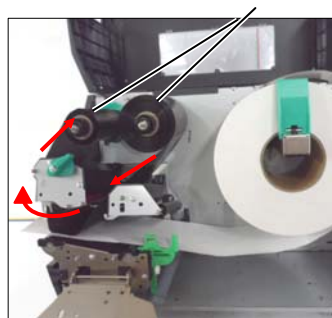

Outside Wound Ribbon

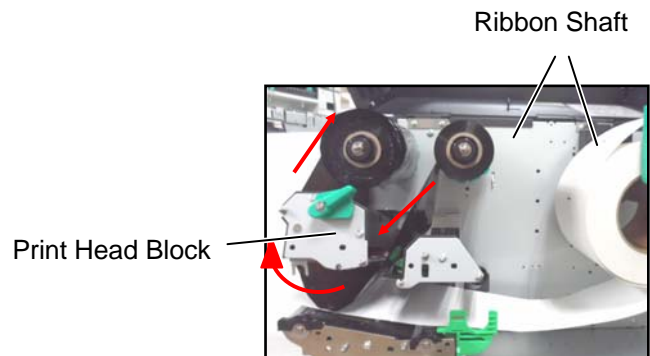

Inside Wound Ribbon

NOTE:

To check or change settings on which type of Ribbon winding to be used, you must go to SYSTEM Mode in the Printer. For more details refer to **Key Operation Specification, "8.4.1 PRINTER SET"**.

2.3.2 Loading the Ribbon (Cont.)

3. Push Ribbon along the Ribbon Shafts to a position where the ribbon is fully to the Left against the stoppers when fitted.
4. Lower the Print Head Block and set the Ribbon Shaft Holder Plate aligning its holes with the Ribbon Shafts.
5. Take up any slack in the ribbon. Wind the leading tape onto the ribbon take-up roll until the ink ribbon can be seen from the front of the printer.

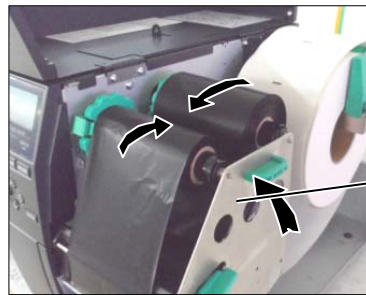

Ribbon Shaft Holder Plate

6. Turn the Head Lever to **Lock** position to close the Print Head.
7. Close the Top Cover.

2.4 Connecting the Cables to Your Printer

The following paragraphs outline how to connect the cables from the printer to your host computer, and will also show how to make cable connections to other devices. Depending on the application software you use to print labels, there are 5 ways to connect the printer to your host computer. These are:

- An Ethernet connection using the printer's standard LAN connector.
- A USB cable connection between the printer's standard USB connector and your host computer's USB port. (Conforming to USB 2.0)
- A serial cable connection between the printer's optional RS-232 serial connector and one of your host computer's COM ports.
- A parallel cable connection between the printer's optional parallel connector and your host computer's parallel port (LPT).
- Wireless LAN using an optional Wireless LAN board.

For details, refer to **APPENDIX 2**.

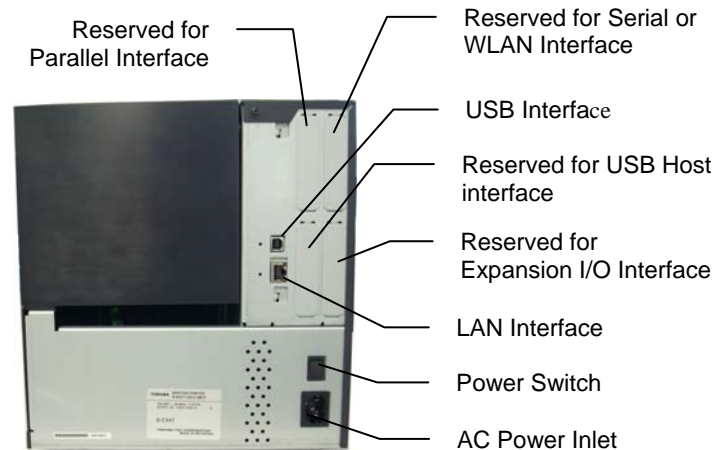

2.5 Turning the Printer ON/OFF

When the printer is connected to your host computer it is good practice to turn the printer ON before turning on your host computer and turn OFF your host computer before turning off the printer.

2.5.1 Turning ON the Printer

CAUTION!

Use the power switch to turn the printer On/Off. Plugging or unplugging the Power Cord to turn the printer On/Off may cause fire, an electric shock, or damage to the printer.

NOTE:

If a message other than ON LINE appears on the display or the ERROR LED lamp is illuminated, refer to **Section 5.1, Error Messages**.

1. To turn ON the printer power, press the Power Switch as shown in the diagram below. Note that (|) is the power ON side of the switch.



2. Check that the ON LINE message appears in the LCD Message Display and that the ON LINE and POWER LED lights are illuminated.

2.5.2 Turning OFF the Printer

CAUTION!

1. Do not turn off the printer power while the media is being printed, as this may cause a paper jam or damage to the printer.
2. Do not turn off the printer power while the ON LINE lamp is blinking as this may cause damage to your computer.

1. Before turning off the printer Power Switch verify that the ON LINE message appears in the LCD Message Display and that the ON LINE LED light is on and is not flashing.
2. To turn OFF the printer power press the Power Switch as shown in the diagram below. Note that (O) is the power OFF side of the switch.



2.6 Printer Setting

Depending on the settings of your host computer or the interface being used it may be necessary to change the printer parameter settings.

Follow the procedures described below to change the printer parameter settings to correspond to your environment.

NOTE:

*Incorrect settings can cause the printer not to function correctly. If you have any problems with the parameter settings, please contact your nearest TOSHIBA TEC service representative. For the settings this manual does not cover, please contact your nearest TOSHIBA TEC service representative, or refer to the **B-EX4T Series Key Operation Specification manual**.*

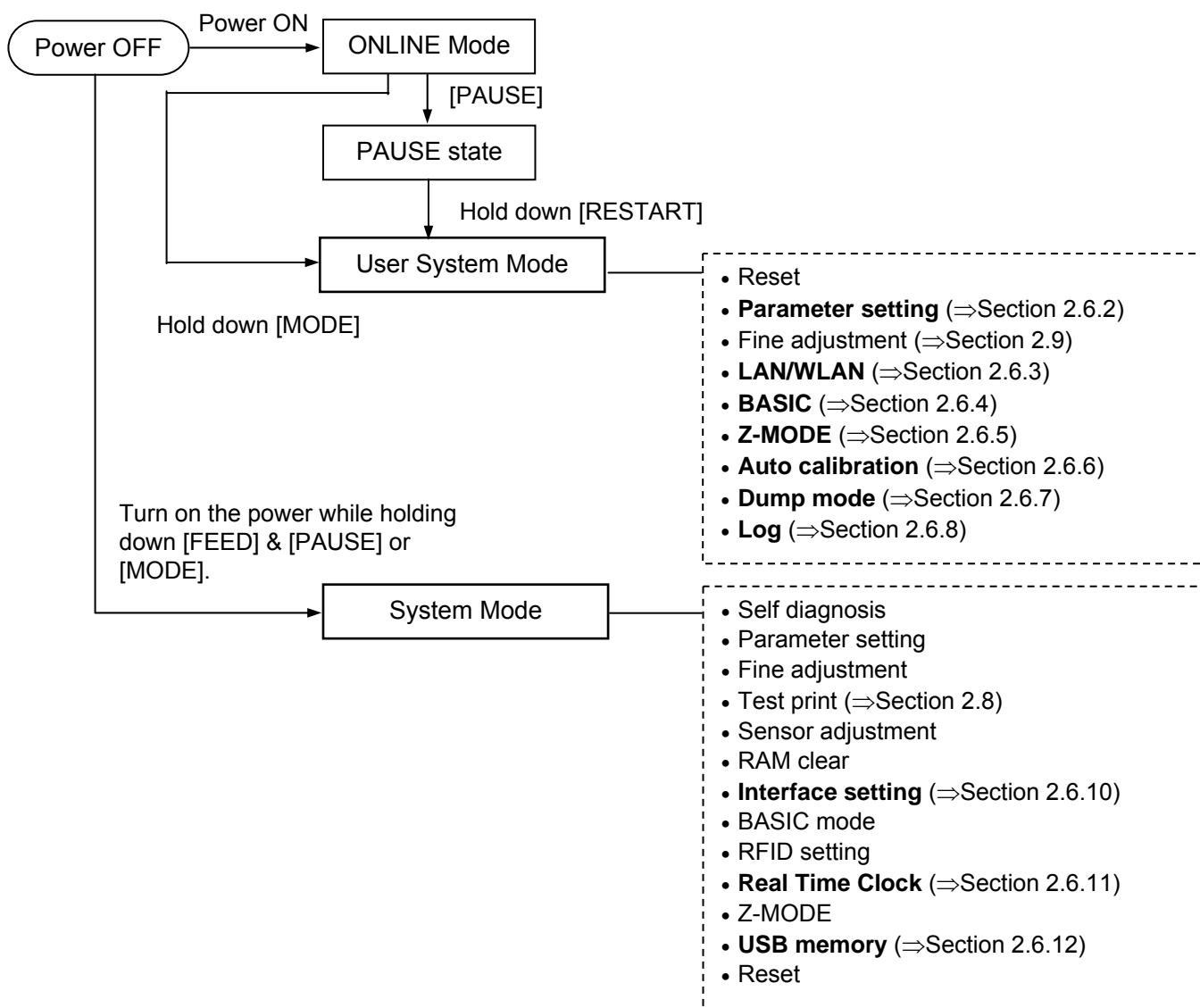

2.6 Printer Setting (Cont.)

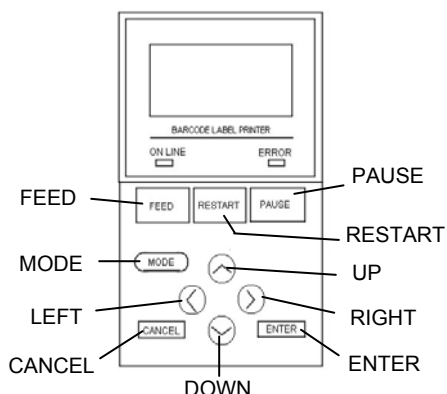

■ Key functions in system mode

| Key | Function |
|------------------------------|--|
| [MODE] | Returns to the system mode menu. |
| [CANCEL] or [FEED]+[RESTART] | Returns to the previous menu. |
| [ENTER] or [PAUSE] | Displays the next screen. Saves the settings and returns to the previous menu. |
| [UP] or [RESTART] | Moves the cursor up. ^(Note 1) Increases a value. ^(Note 2) |
| [DOWN] or [FEED] | Moves the cursor down. ^(Note 1) Decreases a value. ^(Note 3) |
| [LEFT] | Moves the cursor to the left. ^(Note 3) |
| [RIGHT] | Moves the cursor to the right. ^(Note 3) |

NOTES:

1. The cursor will not scroll from the bottom to the top or top to bottom of a menu.
2. The value will not increase or decrease any further than the maximum or minimum values of a parameter.
3. The cursor will not move any further than the left- or right-most positions of a field.
4. Any values changed will not become effective if the printer is turned off without pressing the [ENTER] key.

2.6.1 User System Mode

How to enter the User System Mode

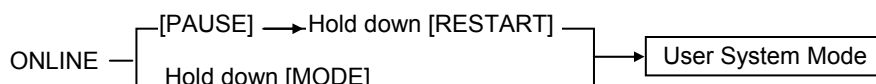

The User System Mode consists of the following menus.

| |
|---|
| <1>RESET Used to reset the printer. |
| <2>PARAMETER SET (⇒ Section 2.6.2) Used to set the printer parameters. |
| <3>ADJUST SET (⇒ Section 2.9) Used to fine adjust the print start position, cut position, etc. |
| <4>LAN/WLAN (⇒ Section 2.6.3) Used to enable or disable the LAN communication and SNMP. |
| <5>BASIC (⇒ Section 2.6.4) Used to set the function of basic program when it is loaded to the printer. |
| <6>Z-MODE (⇒ Section 2.6.5) Same as BASIC |
| <7>AUTO CALIB (⇒ Section 2.6.6) Used to enable or disable the automatic calibration function. |
| <8>DUMP MODE (⇒ Section 2.6.6) Used to print the data in the receive buffer for debugging purposes. |
| <9>LOG (⇒ Section 2.6.7) Used to save print logs in USB memory. |

2.6.2 Parameter Setting

USER SYSTEM MODE

| | |
|---|------------------|
| ▲ | <1>RESET |
| | <2>PARAMETER SET |
| | <3>ADJUST SET |
| ▼ | <4>LAN/WLAN |

The Parameter Set menu allows the printer parameter settings to be modified.

The following table shows the contents of the Parameter Set menu.

Contents of the Parameter Set Menu

| Menu | Sub menu | Parameter |
|---------------|-----------------------------------|------------------|
| Parameter set | Printer Set (Section 2.6.2.1) | MEDIA LOAD |
| | | FORWARD WAIT |
| | | FW/BK ACT |
| | | HU CUT/RWD |
| | | RBN SAVE |
| | | PRE PEEL OFF |
| | | BACK SPEED |
| | Software Set (Section 2.6.2.2) | FONT CODE |
| | | TYPE OF RIBBON |
| | | ZERO FONT |
| | | CODE |
| | | PEEL OFF STATUS |
| | | USB I/F STATUS |
| | | FEED KEY |
| | | KANJI CODE |
| | | EURO CODE |
| | | AUTO HD CHK |
| | | WEB PRINTER |
| | | RBN NEAR END |
| | | EX I/O |
| | | LBL/RBN END |
| | | MAX CODE |
| | | XML |
| | | THRESHOLD SELECT |
| | ENERGY TYPE | |
| | PW SAVE TIME | |
| | Panel (Section 2.6.2.3) | LCD LANGUAGE |
| | | DISPLAY |
| | | CONTRAST |
| | Password (Section 2.6.2.4) | PASSWORD |

2.6.2 Parameter Setting (Cont.)

NOTE:
Underlined setting is the factory default.

2.6.2.1 Printer Set

(1) MEDIA LOAD

Determines how the use of the [FEED] key enables the printer to detect the home position. This parameter is effective only when the sensor type is set to other than "None".

- OFF Media loading function is disabled (Same as a feed by [FEED] key)
- STD When the [FEED] key is pressed after the printer is tuned on, reset in batch mode, or the print head is closed, the printer detects the next gap/black mark and feeds the paper from the sensor to the print start position.
- ECO When the [FEED] key is pressed after the printer is tuned on, reset in batch mode, or the print head is closed, the printer detects the next gap/black mark and feeds the paper to the print start position based on the last label pitch printed.
- ECO+Bfeed Since optional ribbon saving module is not available to the B-EX4T2, MEDIA LOAD setting and the printer behavior will be automatically changed to "ECO" setting even if "ECO+Bfeed" is selected for these models.

(2) FORWARD WAIT

This parameter allows you to choose whether or not to activate the auto forward wait function. This function, used in the cut mode, automatically feeds the media forward if there is more than a 1-second idle time after printing. This prevents the top edge of the media from curling.

- OFF Disables the auto forward feed wait
- ON Enables the auto forward feed wait → ①

① When ON is selected, the feed amount can be fine adjusted.

(3) FORWARD WAIT POS.

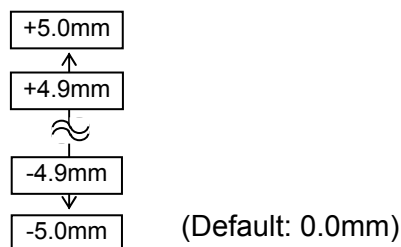

NOTE:

1. If the pitch of the media used for the previous issue was less than 20mm, the forward wait will not be activated regardless of the parameter setting.
2. The media will stay at the forwarded position even if the power is turned off/on, the printer is reset, the print head is opened/closed.

2.6.2 Parameter Setting (Cont.)

(4) FW/BK ACT.

- MODE1 The printer waits for next issue after 13.7-mm media has been fed forward.
- MODE2 When thermal transfer and cut mode are selected, the printer feeds 6-mm media backward, then waits for next issue after 3-mm media has been fed forward. From this position, the printer starts the on-the-fly printing for next issue. The 3-mm distance to the home position is fed at 3 ips.

NOTE:

Pre-strip function is automatically enabled when the print speed is set to 10 ips or faster. However, the print speed is corrected depending on the EX I/O parameter setting, as follows.

*EX I/O: TYPE 1
10 ips (203 dpi)
8 ips (305 dpi)
EX I/O: TYPE 2
Specified speed*

(5) PRE PEEL OFF

Select whether to activate the pre-strip function. When this parameter is set to ON, the top edge of a label is separated (pre-stripped) from the backing paper before the label is printed. This function is intended to make the strip issue easier in the case of labels that are hard to strip due to the label density, strength of the adhesive used, or the print speed.

- OFF Disables pre peel off
- ON Enables pre peel off

(6) BACK SPEED

Select back feed speed.

In strip issue a back feed speed of 3 ips may cause the correct distance not to be fed due to a lack of torque, slippery media surface, etc. In such cases reduce the back feed speed to 2 ips to ensure the correct feed amount.

- STD 3ips
- LOW 2ips

(7) TYPE OF RIBBON

Select type of ribbon.

When a coating side of the ribbon is the outside, chooses CSO.
When a coating side of the ribbon is the inside, chooses CSI.

- CSO Coated side out
- CSI Coated side in

2.6.2 Parameter Setting (Cont.)

2.6.2.2 Software Set

(1) FONT CODE

Allows you to select the character code used for printing. Printed characters differ depending on the chosen character code and font.

- PC-850
- PC-852
- PC-857
- PC-8
- PC-851
- PC-855
- PC-1250
- PC-1251
- PC-1252
- PC-1253
- PC-1254
- PC-1257
- LATIN9
- Arabic
- PC-866
- UTF-8

NOTE:

The following fonts do not support a zero with a slash.

(If a zero with a slash is specified, a zero without a slash will be printed.)

[Bit map fonts]

OCR-A, OCR-B, GOTHIC725

Black, Kanji, Chinese character

[Outline fonts]

Price fonts 1, 2, and 3,

DUTCH801 Bold, BRUSH738

Regular, GOTHIC725 Black,

TrueType font

(2) ZERO FONT

Allows you to select the way the zero character is printed. Select between "0" and "Ø".

- 0 No slash used
- Ø Slash used

(3) CODE

Select the command control code to be used.

- AUTO Automatically selected.
- {,|,}
- ESC, LF, NUL
- MANUAL The control code is specified by the user. → ①

- ① When MANUAL is selected, you need to specify each of the control codes 1 to 3 with a hex. code.

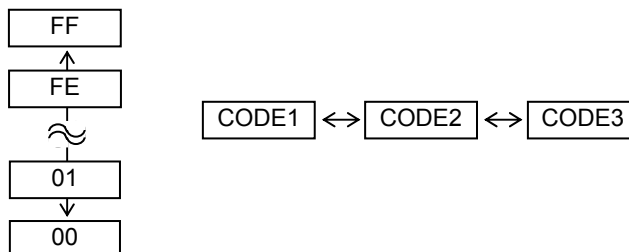

2.6.2 Parameter Setting (Cont.)

(4) PEEL OFF STATUS

Specifies whether the printer sends a strip wait status to the host in response to a status request command.

- OFF
- ON

(6) USB I/F STATUS

Specifies whether to return a response to the host via USB.

- OFF Disables sending a response via USB
- ON Enables sending a response via USB

(7) FEED KEY

Selects the function of the FEED key.

- FEED Feeds one label.
- PRINT Prints the data in the image buffer (The last label printed)

(8) KANJI CODE

Select the KANJI code.

- TYPE1 Windows code
- TYPE2 Original code

(9) EURO CODE

Specifies the Euro code (€).

“20” to “FF” (Specify the hex code in 2 bytes of ASCII code)

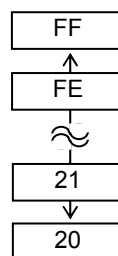

(10) AUTO HD CHK

Select whether to perform the auto print head check when the printer is powered on.

- OFF Auto print head check is not performed.
- ON Auto print head check is performed.

2.6.2 Parameter Setting (Cont.)

NOTE:
Since detecting the remaining ribbon length has a margin of error, use the specified length as a guide.

(11) WEB PRINTER

Select whether to use the printer as a web printer. When the web printer is enabled, the status of the printer connected to a network can be monitored through the web browser.

- OFF Disables web printer function
- ON INTERNAL Enables web printer function (using internal memory)
- ON EXTERNAL Enables web printer function (using an external usb memory)

(12) RBN NEAR END

Select the remaining ribbon length when the ribbon near end is detected.

- OFF Ribbon near end is not detected.
- 30m Ribbon near end is detected when the remaining ribbon is 30-m long. (Equivalent to ribbon diameter of 38 mm)
- 70m Ribbon near end is detected when the remaining ribbon is 70-m long. (Equivalent to ribbon diameter of 43 mm)

(13) EX.I/O

Select the type of expansion I/O interface operating mode. This parameter needs to be set depending on the expansion I/O control specification of the device to be connected via the expansion I/O interface.

- TYPE1 Standard mode
- TYPE2 In-line mode

(14) LBL/RBN END

Select the operation to be performed when a label end or ribbon end is detected.

- TYPE1 When a label/ribbon end is detected in the middle of printing, the printer immediately stops printing.
- TYPE2 Selectable only when the ribbon saving function is not activated. When a label/ribbon end is detected in the middle of printing, the printer prints the half-finished label as far as possible, and stops when the next label is at the home position.

NOTE:
The type specified by the command may differ from the actual mode, depending on the status of this parameter. Also, the data transmission method is slightly different. For details, refer to the External Equipment Interface Specification.

(15) MAXI CODE

Select the Maxicode specification.

- TYPE1 Compatible with the current version
- TYPE2 Special specification

2.6.2 Parameter Setting (Cont.)

(16) XML

Select the type of XML data to be printed.

- OFF Disables XML data printing.
- STD Standard specification
- ORACLE Oracle
- SAP SAP
- STD EXT Standard specification (External memory)
- ORACLE EXT Oracle using an external memory
- SAP EXT SAP using an external memory

(17) THRESHOLD SELECT

This parameter is to choose which threshold value for the media sensor to validate.

- REFLECT Reflective sensor
- TRANS. Transmissive sensor

Then, choose which value to use.

- MANUAL SET Threshold set in the Threshold mode takes effect.
- COMMAND SET Threshold set by command takes effect.

(18) ENERGY TYPE

This parameter is intended to make the printer perform appropriate printing for the supplies to be used. If you use a different supply from the setting, poor printing may occur.

- TRANSFER Thermal transfer print method → ①
- DIRECT Thermal direct print method → ②

① When TRANSFER is selected for the Energy type parameter, choose a ribbon type.

Case of B-EX4T2-GS/TS

- Wax1 Wax 1
- Wax2 Wax 2
- Wax3 Wax 3
- Semi resin1 Semi-resin 1
- Semi resin2 Semi-resin 2
- Semi resin3 Semi-resin 3
- Resin1 Resin 1
- Resin2 Resin 2
- Reserve1 to Reserve2 Reserved

Case of B-EX4T2-HS

- Resin1 Resin 1
- Resin2 Resin 2
- Reserve1 to Reserve8 Reserved

② When DIRECT is selected for the Energy type parameter

- Standard Standard
- Reserve1 to Reserve9 Reserved

2.6.2 Parameter Setting (Cont.)

NOTE:
For details of the power saving mode, refer to Section 3.4 Power Save Function.

(19) PW SAVE TIME

Sets the length of time until the printer enters the power saving mode. (Unit: minute)

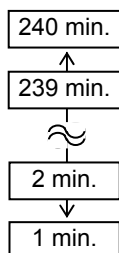

(Default: 15 minutes)

2.6.2.3 PANEL

(1) LCD LANGUAGE

Choose a language in which the LCD messages are displayed.

NOTE:

- The language displayed on panel is Japanese when Japanese is selected, and English when English, German, French, Dutch, Spanish, Italian; or Portuguese is selected.

- ENGLISH
- GERMAN
- FRANCH
- DUTCH
- SPANISH
- JAPANESE
- ITALIAN
- PORTUGUESE
- SIMP. CHINESE

(2) DISPLAY

Choose whether the model name, the number of labels printed and the IP address are displayed or hidden.

- MACHINE NAME OFF: Hidden
 ON: Displayed
- PRINT PAGE OFF: Hidden
 ON: Displayed
- IP ADDRESS OFF: Hidden
 ON: Displayed

(3) CONTRAST

Adjust the contrast of the LCD.

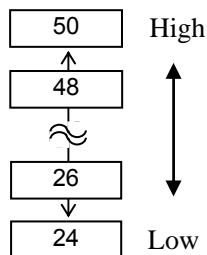

(Default: 40)

2.6.2 Parameter Setting (Cont.)

2.6.2.4 PASSWORD

(1) PASSWORD

This parameter is for the system administrator only. Please do not change the setting for this parameter.

2.6.3 Enabling LAN/WLAN

The LAN/WLAN menu allows selecting whether or not to enable the LAN communication and SNMP.

| USER SYSTEM MODE | |
|------------------|------------------|
| ▲ | <1>RESET |
| □ | <2>PARAMETER SET |
| □ | <3>ADJUST SET |
| ▼ | <4>LAN/WLAN |

(1) LAN/WLAN

- OFF LAN and Wireless LAN are disabled.
- ON (AUTO) Automatically selected.
- ON (LAN) LAN is enabled.
- ON (WLAN) Wireless LAN is enabled.

(2) SNMP

- OFF SNMP is disabled.
- ON SNMP is enabled.

2.6.4 Basic Program Setting

The following table shows the contents of the Basic program setting menu.

| USER SYSTEM MODE | |
|------------------|------------------|
| ▲ | <2>PARAMETER SET |
| | <3>ADJUST SET |
| | <4>LAN/WLAN |
| ▼ | <5>BASIC |

Contents of the Basic Program Setting Menu

| Menu | Sub menu |
|-------|------------------|
| BASIC | BASIC |
| | FILE MAINTENANCE |
| | TRACE |
| | EXPAND MODE |

(1) BASIC

Select whether to enable the BASIC program.

- OFF Disables BASIC program.
- ON Enables BASIC program.

(2) FILE MAINTENANCE

The block number and BASIC program file name (up to 12 characters) stored in the BASIC program storage area are displayed. If the file name exceeds 12 characters, the overflowing characters are not displayed.

When no file is stored, a hyphen ("-") is displayed in place of the file name.

(3) TRACE

Allows you to enable tracing in the BASIC program.

- OFF Disables tracing the BASIC program.
- ON Enables tracing the BASIC program.

(4) EXPAND MODE

The printer switches the mode to execute the BASIC program.

2.6.5 Enabling Z-Mode

| USER SYSTEM MODE | |
|------------------|---------------|
| ▲ | <3>ADJUST SET |
| | <4>LAN/WLAN |
| | <5>BASIC |
| ▼ | <6>Z-MODE |

The Z-Mode menu allows you to select whether or not to enable the Z-Mode.

(1) Z-MODE

- OFF Z-Mode is disabled.
- ON SETTING OFF Z-Mode is enabled. BASIC system mode program is not started automatically.
- ON SETTING ON Z-Mode is enabled. BASIC system mode program is started automatically.

2.6.6 Automatic Calibration

USER SYSTEM MODE

| | |
|---|---------------|
| ▲ | <4>LAN/WLAN |
| □ | <5>BASIC |
| □ | <6>Z-MODE |
| ▼ | <7>AUTO CALIB |

NOTE:

- Since the head-up function is not provided to the B-EX4T2 and B-EX6T2, the setting and the printer behavior will be automatically changed to "ON TRANS", "ON REFLECT", "ON ALL" even if "+Bfeed" is selected for these models.

The Auto Calibration menu allows you to select whether or not to enable automatic calibration at power on time. When automatic calibration is activated, the printer feeds the media for about 160 mm each time the power is turned on or the print head is open then closed to detect the print start position.

(1) AUTO CALIB

- | | |
|--------------------|--|
| • OFF | Disabled. |
| • ON TRANS. | Enabled. (Transmissive sensor) |
| • ON REFLECT | Enabled. (Reflective sensor) |
| • ON ALL | Enabled. (Transmissive & Reflective sensors) |
| • ON TRANS.+Bfeed | same as "ON TRANS" setting |
| • ON REFLECT+Bfeed | same as "ON REFLECT" setting |
| • ON ALL+Bfeed | same as "ON ALL" setting |

NOTES:

1. When AUTO CALIB is enabled, an automatic calibration is performed at an open/close of the print head and at a power on time.
2. After the automatic calibration is performed, the media length, effective print length, sensor type and whether the ribbon is used or not, obtained through the calibration, will take effect until next calibration is performed or the printer power is turned off. (Settings specified by commands are ignored.)
3. This function is available only when the media pitch is 10.0 mm to 150.0 mm.
4. When the printer cannot detect the second black mark/gap, it will continue to feed the media for up to 500.0mm. If a black mark/gap is still not detected, the printer will stop, resulting in a paper jam.
5. During an automatic calibration, the printer also feeds the ribbon. Even if the ribbon is not loaded, this will not result in an error. However, the print condition will be automatically changed to "No ribbon" after the calibration ends.
6. When the cutter is installed and a previous issue was performed in cut issue mode, the media is cut and ejected after the automatic calibration is completed.
7. When a label end occurs during an automatic calibration, the printer stops, resulting in an error. Loading new media and closing the print head can clear the error and resume the automatic calibration.
8. Since the optional ribbon saving module is not available for the B-X4T2, Setting + Bfeed will have no effect and the setting will revert to without BFeed.
9. The feed speed during automatic calibration is 3 ips.
10. Do not open the print head during automatic calibration. The subsequent printer operation is not guaranteed. If you open the print head, turn off the power and back to on.

2.6.7 Dump Mode Setting

| USER SYSTEM MODE | |
|------------------|---------------|
| ▲ | <5>BASIC |
| | <6>Z-MODE |
| | <7>AUTO CALIB |
| ▼ | <8>DUMP MODE |

In Dump Mode, the data in the receive buffer is printed. The data is expressed in hexadecimal values. This operation allows verification of the programming commands or the debug of the program.

(1) BUFFER

Select the receive buffer to dump.

- RS-232C RS-232C receive buffer
- CENTRONICS Centronics receive buffer
- LAN Network I/F receive buffer
- BASIC1 BASIC Interpreter:
I/F → Interpreter buffer
- BASIC2 BASIC Interpreter:
Interpreter buffer → I/F
- USB USB receive buffer
- RFID RFID receive buffer

(2) DUMP LIST

This parameter is to choose the output destination.

- USB MEMORY Saves in the USB memory. → ①
- PRINT Prints out → ②

- ① When USB MEMORY is selected:
A file is automatically created in the USB memory and named in the following format based on the printer model and saved date.

/ATA0/DUMP/B-EX4T1_DUMP_1007291030.BIN
(e.g. B-EX4T Type1, 10:30, July 29, 2010)

- ② When PRINT is selected:
Choose a printing method.
- ON DEMAND Prints 166 lines of data (approx. 50 cm), then stops. Subsequent data is printed when the [ENTER] key is pressed.
 - ALL Prints all data in the receive buffer.

NOTES:

1. If a file with the same name already exists in the USB memory, it will be overwritten.
2. Selecting "RS-232C" or "CENTRONICS" without the optional board installed causes a 0-KB file to be output.
3. If an error occurs while using the USB memory, the error message is displayed. For details, refer to Section 2.6.12 Copying Data to/from USB Memory.

2.6.7 Dump Mode Setting (Cont.)

The data in the receive buffer is printed as follows.

Print Conditions

- Printing width: 3.9 inches (Approx. 100 mm)
- Sensor selection: None
- Print speed: 6"/sec. (203 dpi)
5"/sec. (300 dpi)
3"/sec. (600dpi)
- Printing mode: Depends on the selection in use.
- 16 bytes/line
- Data is printed in the order from the new one to the old.
- Data specified by the receive buffer write pointer will be printed in boldface.

```

00 00 00 00 00 00 00 00 00 00 00 00 00 00 00 00 .....
00 00 00 00 00 00 00 00 00 00 00 00 00 00 00 00 .....
00 00 00 00 00 00 00 00 00 00 00 00 00 00 00 00 .....
00 00 00 00 00 00 00 00 00 00 00 00 00 00 00 00 .....
7B 41 58 3B 2B 30 30 30 2C 2B 30 30 30 2C 2B 30 {AX;+000,+000,+0
30 7C 7D 7B 44 30 37 37 30 2C 31 31 30 30 2C 30 0}|{D0760,1100,0
37 34 30 7C 7D 7B 43 7C 7D 7B 4C 43 3B 30 30 33 740}|{C}|{LC;003
30 2C 30 30 32 30 2C 30 30 33 30 2C 30 36 36 30 0,0020,0030,0660
2C 30 2C 32 7C 7D 7B 4C 43 3B 30 30 37 30 2C 30 0,2}|{LC;0070,0
30 32 30 2C 30 30 37 30 2C 30 36 36 30 2C 30 2C 020,0070,0660,0,
39 7C 7D 7B 4C 43 3B 30 30 35 30 2C 30 30 32 30 9}|{LC;0050,0020
.....
44 45 46 47 48 49 4A 7C 7D 7B 50 43 31 30 3B 30 DEFGHIJ}|{PC10;0
33 35 30 2C 30 34 30 30 2C 31 2C 31 2C 4B 2C 30 350,0400,1,1,K,0
30 2C 42 3D 41 42 43 44 65 66 67 68 69 6A 6B 6C 0,B=ABCDefghijkl
.....
6D 6E 6F 70 7C 7D 7B 50 56 30 32 3B 30 33 33 30 mnop}|{PV02;0330
2C 30 36 36 30 2C 30 32 37 30 2C 30 32 35 30 2C 0660,0270,0250,
41 2C 30 30 2C 42 3D 42 7C 7D 7B 50 56 30 33 3B A,00,B=B}|{PV03;
.....
3B 30 39 30 30 2C 30 31 38 30 2C 54 2C 48 2C 30 ;0900,0180,T,H,0
35 2C 41 2C 30 3D 31 32 33 34 35 36 37 38 39 30 5,A,0=1234567890
41 42 43 44 45 7C 7D 00 00 00 00 00 00 00 00 00 ABCDE}|{.....
.....

```

NOTE:
 If an error occurs while printing, the printer stops printing and shows an error message.
 To clear the error, press the [PAUSE].
 After clearing the error the printer does not resume printing automatically.

Receive Buffer Size

| Interface | B-EX4T2-GS/TS/HS |
|------------|-------------------|
| RS-232C | 1MB (65536 lines) |
| Centronics | 1MB (65536 lines) |
| LAN | 1MB (65536 lines) |
| BASIC 1 | 8KB (512 lines) |
| BASIC 2 | 8KB (512 lines) |
| USB | 1MB (65536 lines) |
| RFID | 8KB (512 lines) |

Required Media Length

| Interface | B-EX4T2-GS/TS | B-EX4T2-HS |
|------------|---------------|------------|
| RS-232C | 198.2 m | 198.6 m |
| Centronics | 198.2 m | 198.6 m |
| LAN | 198.2 m | 198.6 m |
| BASIC 1 | 2 m | 2 m |
| BASIC 2 | 2 m | 2 m |
| USB | 198.2 m | 198.6 m |
| RFID | 2 m | - |

*: Media length required for printing all data in the receive buffer.

2.6.8 Logging

The Log menu allows the saving of print logs to USB memory.

USER SYSTEM MODE

| | |
|---|---------------|
| ▲ | <6>Z-MODE |
| | <7>AUTO CALIB |
| | <8>DUMP MODE |
| ▼ | <9>LOG |

(1) LOG

- PRINTER TO USB Saves print logs in the USB memory.

A file is automatically created in the USB memory and named in the following format based on the printer model and saved date.

/ATA0/LOG/B-EX4T1_LOG_1007291030.TXT
(e.g. B-EX4T Type1, 10:30, July 29, 2010)

NOTES:

1. If a file with the same name already exists in the USB memory, it will be overwritten.
2. If an error occurs while using the USB memory, the error message is displayed. For details, refer to Section 2.6.12 Copying Data to/from USB Memory. After clearing the error the printer does not resume logging automatically.

2.6.9 System Mode

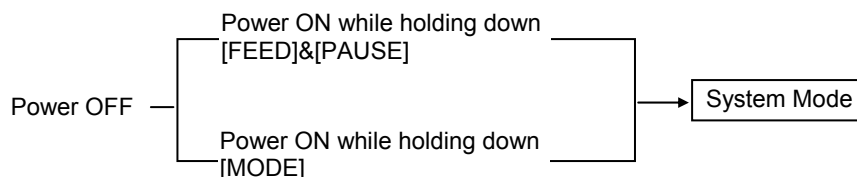
How to enter the System Mode

The System Mode consists of the following menus.

| |
|---|
| <1>DIAG. Used to check and print the printer system information and maintenance counter status. |
| <2>PARAMETER SET (⇒ Section 2.6.2) Used to set the parameters for each printer function. |
| <3>ADJUST SET (⇒ Section 2.9) Used to fine adjust the print position, cut position, print tone, etc. |
| <4>TEST PRINT (⇒ Section 2.8) Used to perform print tests. |
| <5>SENSOR ADJUST Used to check the sensor statuses and set each sensor. |
| <6>RAM CLEAR Used to perform a RAM clear. DO NOT USE this menu. |
| <7>INTERFACE (⇒ Section 2.6.10) Used to set the interface parameters. |
| <8>BASIC (⇒ Section 2.6.4) Used to set the function of basic program when it is loaded to the printer. |
| <9>FOR FACTORY Used for an in-process inspection. DO NOT use this menu. |
| <10>RFID Used to set RFID related parameters. (see Installation Manual in each RFID kit) |
| <11>RTC (⇒ Section 2.6.11) Used to set the date and time of the real time clock, enable or disable the low battery check, and choose a real time renewal timing. |
| <12>Z-MODE (⇒ Section 2.6.5) Same as BASIC |
| <13>USB MEMORY (⇒ Section 2.6.12) Used to copy data to/from USB memory. |
| <14>RESET Used to reset the printer. |

2.6.10 Interface Setting

The Interface menu allows configuring printer interface parameters. The following table shows the contents of the Interface menu.

SYSTEM MODE

| | |
|---|------------------|
| ▲ | <4>TEST PRINT |
| | <5>SENSOR ADJUST |
| | <6>RAM CLEAR |
| ▼ | <7>INTERFACE |

Contents of the Interface Menu

| Menu | Sub menu | Parameter |
|-----------|--------------|-------------------|
| Interface | NETWORK | LAN/WLAN |
| | | SNMP |
| | | SETTING |
| | | BASIC INFORMATION |
| | | IP ADDRESS |
| | | GATEWAY ADDRESS |
| | | SUBNET MASK |
| | | SOCKET PORT |
| | | PORT NUMBER |
| | | DHCP |
| | | DHCP CLIENT ID |
| | | DHCP HOST NAME |
| | | WLAN STANDARD |
| | | WLAN MODE |
| | | DEFAULT KEY |
| | | 802.11B CHANNEL |
| | | 802.11B BAUD |
| | | 802.11G CHANNEL |
| | | 802.11G BAUD |
| | | WINS |
| | WINS ADDRESS | |
| | LPR | |
| | USB | |
| | RS-232C | SPEED |
| | | DATA LENGTH |
| | | STOP BIT |
| | | PARITY |
| | CENTRO. | CONTROL |
| | | ACK/BUSY |
| | | INPU PRIME |
| | | PLUG & PLAY |

2.6.10 Interface Setting (Cont.)

2.6.10.1 Network Setting

(1) LAN/WLAN

- OFF LAN and Wireless LAN are disabled.
- ON (AUTO) Automatically selected.
- ON (LAN) LAN is enabled.
- ON (WLAN) Wireless LAN is enabled.

(2) SNMP

- OFF SNMP is disabled.
- ON SNMP is enabled.

(3) BASIC INFORMATION

The following information is displayed.

IP Address
Gateway address
Subnet mask
Socket port status
Socket port number

(4) IP ADDRESS

Set the IP address.

192 ↔ 168 ↔ 020 ↔ 010

(5) GATEWAY ADDRESS

Set the gateway address.

192 ↔ 168 ↔ 020 ↔ 010

(6) SUBNET MASK

Set the subnet mask.

255 ↔ 255 ↔ 255 ↔ 000

(7) SOCKET PORT

Select whether to enable or disable the socket port.

- OFF Socket port is disabled.
- ON Socket port is enabled.

2.6.10 Interface Setting (Cont.)

(8) PORT NUMBER

Set the port number.

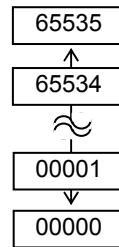

(9) DHCP

Select whether to enable/disable DHCP.

- OFF DHCP is disabled.
- ON DHCP is enabled.

(10) DHCP CLIENT ID

Select ASCII or HEX for setting DHCP Client ID.

- ASCII DHCP client ID is entered with ASCII code. → ①
- HEX DHCP client ID is entered with Hex. code. → ②

① When ASCII is selected:
Enter 64 characters with ASCII code.

② When HEX is selected:
Enter 64 characters with Hex. code.

(11) DHCP HOST NAME

Enter 32 characters with ASCII code.

(12) WLAN STANDARD

- 11b/g
- 11b
- 11g

**2.6.10 Interface Setting
(Cont.)**

(13) WLAN MODE

Set the connection mode and authentication in reference to the following table.

| | | | | |
|----------|-------------|-------------|----------|--------|
| ADHOC | | | | OFF |
| | | | | WEP40 |
| | | | | WEP104 |
| INFRA | OPEN | | | OFF |
| | | | | WEP40 |
| | | | | WEP104 |
| | SHARED | | | WEP40 |
| | | | | WEP104 |
| | 802.1x | OPEN SYSTEM | TLS | WEP40 |
| | | | | WEP104 |
| | | | TTLS | WEP40 |
| | | | | WEP104 |
| | | | LEAP | WEP40 |
| | | | | WEP104 |
| | | | PEAP | WEP40 |
| | | | | WEP104 |
| | | | MD5 | WEP40 |
| | | | | WEP104 |
| | | | EAP-FAST | WEP40 |
| | | | | WEP104 |
| | | SHARED KEY | EAP-MD5 | WEP40 |
| | | | | WEP104 |
| | | NETWORK EAP | | WEP40 |
| | | | | WEP104 |
| WPA | OPEN | TLS | | |
| | | TTLS | | |
| | | LEAP | | |
| | | PEAP | | |
| | | EAP-FAST | | |
| | | NETWORK EAP | | |
| WPA-PSK | | | | |
| WPA2 | OPEN SYSTEM | TLS | | |
| | | TTLS | | |
| | | LEAP | | |
| | | PEAP | | |
| | | EAP-FAST | | |
| | | NETWORK EAP | | |
| WPA2-PSK | | | | |

**2.6.10 Interface Setting
(Cont.)****(14) DEFAULT KEY**

Select a WEP key.

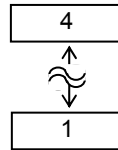

(Default: 1)

(15) 802.11b CHANNEL

Select a channel for 802.11b WLAN.

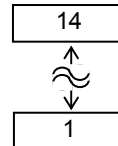

(Default: 1)

(16) 802.11b BAUD

Select a baud rate for 802.11b WLAN.

- 11M
- 5.5M
- 2M
- 1M

(17) 802.11g CHANNEL

Select a channel for 802.11g. WLAN.

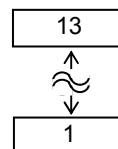

(Default: 1)

(18) 802.11g BAUD

Select the baud rate for 802.11g WLAN.

- 54M
- 48M
- 36M
- 24M
- 18M
- 12M
- 9M
- 6M
- 11M
- 5.5M
- 2M
- 1M

**2.6.10 Interface Setting
(Cont.)****(19) WINS**

- OFF WINS is disabled.
- ON (MANUAL) WINS is enabled. (Manual)
- ON (DHCP) WINS is enabled. (DHCP)

(20) WINS ADDRESS

The WINS address is displayed.

(21) LPR

- OFF LPR is disabled.
- ON LPR is enabled.

2.6.10.2 USB**(1) USB SERIAL ID**

- OFF USB serial ID is disabled.
- ON USB serial ID is enabled.

2.6.10.3 RS-232C**(1) SPEED**

- 2400 bps
- 4800 bps
- 9600 bps
- 19200 bps
- 38400 bps
- 115200 bps

2.6.10 Interface Setting (Cont.)

(2) DATA LENGTH

- 8 bits
- 7 bits

(3) STOP BIT

- 1 bit
- 2 bits

(4) PARITY

- NONE
- EVEN
- ODD

(5) CONTROL

- XON+READY AUTO XON/XOFF mode
- XON+XOFF AUTO XON/XOFF+READY/BUSY mode
- READY/BUSY RTS RTS mode
- XON+XOFF XON/XOFF mode
- READY/BUSY READY/BUSY mode

2.6.10.4 CENTRO.

(1) ACK/BUSY

Select ACK/BUSY timing.

- TYPE1 A rise of ACK signal and a release of BUSY occur at the same time.
- TYPE2 A fall of ACK signal and a release of BUSY occur at the same time.

(2) INPUT PRIME

Resets the printer when the $\overline{\text{INIT}}$ signal is ON.

- OFF
- ON

(3) PLUG & PLAY

- OFF
- ON

2.6.11 Real Time Clock (RTC)

The RTC menu allows the date and time to be set, enables the battery check function, and selects the RTC data renewal timing while labels are being printed.

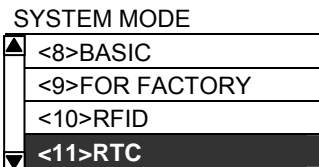

The Real Time Clock Setting is effective only when an optional RTC & USB Host Interface Card, B-EX700-RTC-QM-R, is installed.

(1) DATE TIME

This parameter is to set date and time.

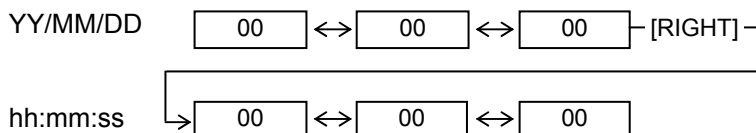

(2) BATTERY CHECK

Enable the low battery check function.

- OFF
- ON

(3) RENEWAL

This parameter is to choose when date and time are updated while printing.

- BATCH The real time clock data is read only for the first label in a batch, the same time is printed on the all labels.
- PAGE The real time clock data is read at the start of printing each label, the real time can be printed on each label.

2.6.12 Copying Data to/from USB Memory

SYSTEM MODE

| |
|------------------|
| ▲ <10>RFID |
| <11>RTC |
| <12>Z-MODE |
| ▼ <13>USB MEMORY |

NOTE:

Usable USB memory's file system is as follows:

| File system | Max. size |
|-------------|-----------|
| FAT (FAT16) | 2GB |
| FAT32 | 8GB |

To use USB memories of the other file system, they need to be formatted to either of the above on the PC in advance.

NOTE:

If a file with the same name already exists in the USB memory, it will be overwritten.

The USB Memory menu allows the copying of data from a USB memory to the printer and saving data from the printer to a USB memory.

USB memory can be used only when an optional RTC & USB Host Interface Card, B-EX700-RTC-QM-R, is installed.

(1) USB TO PRINTER

This parameter is to copy data from a USB memory to the printer.

- COPIED DATA File (*.DAT) containing firmware (BOOT/MAIN/ CG/KANJI/HTML), storage area information, and parameter settings
- CONFIG FILE File (*.CFG) in which the path of the firmware (BOOT/MAIN/ CG/KANJI/HTML) is saved

1. When the file selection screen is displayed choose a file to be copied.

(Example)



2. When the [ENTER] key is pressed, the confirmation message is displayed.

For the CFG files, the message included in the CFG file is displayed prior to the confirmation message.)

3. The data is read from the USB memory. It takes 3 to 5 minutes to read all the information.

(2) PRINTER TO USB

This parameter is to save the firmware (BOOT/MAIN/CG/ KANJI/HTML), storage area information, and parameter settings to a USB memory.

- ALL

1. The confirmation message is displayed.

2. The data is copied to the USB memory. It takes approx. 40 seconds to save all information.

A file is automatically created in the USB memory and named in the following format based on the printer model and saved date.

/ATA0/SYSTEM/B-EX4T1-T1105.DAT
(e.g. B-EX4T Type1, 305 dpi model, November 5)

2.6.12 Copying Data to/from USB Memory (Cont.)

While using the USB memory, the following error message may be displayed.

| Error message | Description |
|--|--|
| FORMAT ERROR Check the settings. | Format error USB memory is not connected. |
| MEMORY WRITE ERR. Check the data and the settings. | Write error |
| MEMORY READ ERR. Check the data and the settings. | Read error |
| MEMORY FULL Free some memory space. | Insufficient free space |
| FILE NOT FOUND Check the data and the settings. | Specified file is not found. |
| UNKNOWN ERROR | Other errors |

Depending on the remaining memory size or the USB memory status, a write error may occur even under the insufficient free space condition.

2.7 Installing the Printer Drivers

2.7.1 Introduction

This chapter describes the use of the TOSHIBA printer driver for the TOSHIBA bar code printer on your Windows host computer; how to install and delete the printer driver. The procedure for adding a LAN port. Cautions and limitations.

2.7.2 General Description

(1) Features

Once you install the TOSHIBA printer driver on your Windows host computer, you can use the TOSHIBA bar code printer in the same way you would a laser or ink jet printer.

You can use the printer by connecting a USB or LAN cable to your host computer.

(2) System Requirements

To install the TOSHIBA printer driver on your host computer the following system requirements are needed.

- Operating system: Windows 2000, Windows XP, Windows Server 2003, Windows Vista, Windows Server 2008, Windows 7 or Windows Server 2008 R2
- Hardware: A DOS-/V (IBM PC/AT compatible) machine running an above operating system.
- Interface:
 - USB interface
 - LAN interface

2.7.3 Installing the Printer Driver

The installation procedure of the printer driver differs depending on the printer model and the connection method.

If an older version of the printer driver has been already installed, you must uninstall it and restart the computer before installing a newer version. See **Section 2.7.10 Uninstalling the Printer Driver**.

■ Installation method for each operating system

| OS | Connection method | |
|---------------------|--|--|
| | Plug and Play is not used. | Plug and Play is used. |
| | LAN | USB |
| Windows 2000 | 2.7.5 Installation under Windows 2000/XP/Server2003 | Section 2.7.7 Installation under Windows 2000 (USB interface with plug and play enabled) |
| Windows XP | | 2.7.8 Installation under Windows XP/Server2003 (USB with Plug & Play enabled) |
| Windows Server 2003 | | |
| Windows Vista | 2.7.6 Installation under Windows Vista/Server2008/7/Server2008R2 | 2.7.9 Installation under Windows Vista/Server 2008/7/Server2008R2 (USB with Plug & Play Enabled) |

2.7.4 Preparation for Installation

- (1) Access the Toshiba TEC web site at the following address and download the printer driver install file “TPCL72M2E.exe” to your local disc.

http://www.toshibatec-ris.com/products/barcode/download/driver_agreement.html

Note: *If you do not agree with the Software License Agreement, you cannot download the file.*

- (2) Double-click the downloaded “TPCL72M2E.exe”, and the “TPCL PRINTER DRIVER – InstallShield Wizard” is displayed. Click the [Next] button.

Note: *Log on as a user with administrative privilege.*

When the User Account Control screen is displayed under Windows Vista/Server2008/7/Server2008R2, click on the “Allow”.

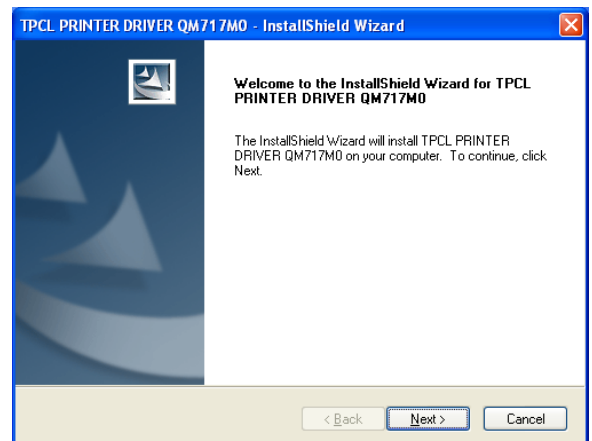
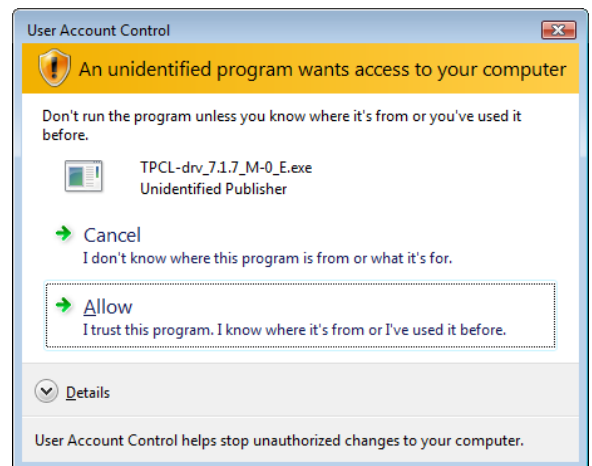

- (3) The “Software License Agreement” is displayed. Select “I accept the terms of the license agreement” and click the [Next] button.

Note: *If you do not agree with the Software License Agreement, you cannot install the driver files.*

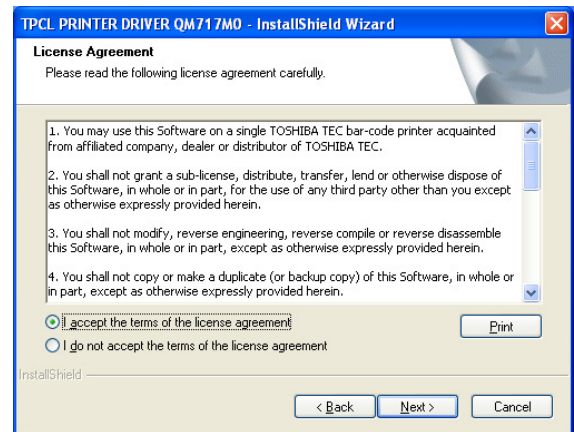

- (4) When you click the [Install] button, the printer driver install files are copied to the directories created in “C:\TEC_DRV”.

Note: *The folder name cannot be changed from “C:\TEC_DRV”.*

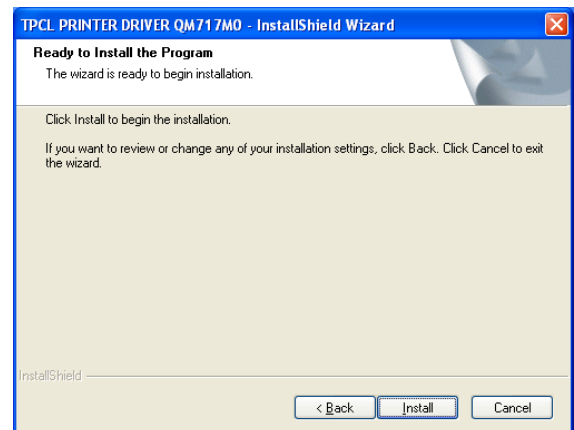

- (5) When the installation is completed, click the [Finish] button.

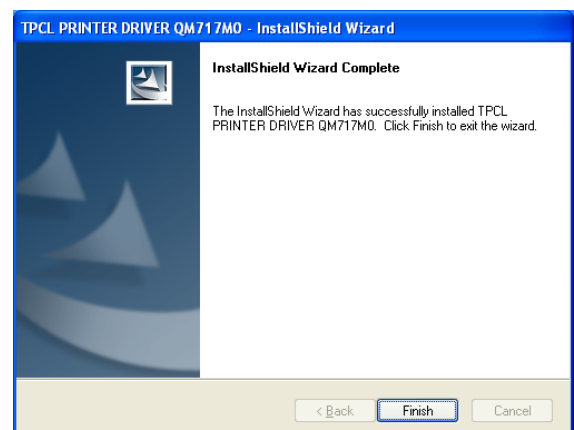

Note: *In the case of Windows Vista/Server2008/7/Server2008R2, the screen on the right will appear. Click the “Install this driver software anyway”.*

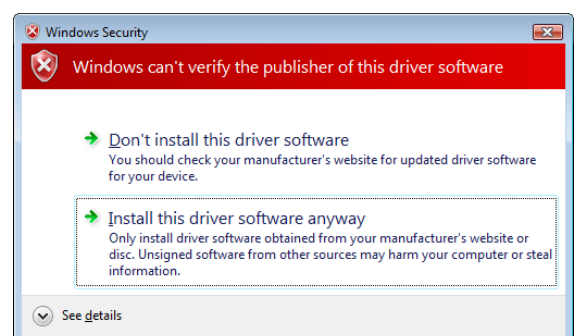

2.7.5 Installation under Windows 2000/XP/Server2003

- (1) Turn on the PC.

Note: Log on as a user with administrative privilege.

- (2) Select the “Start”, “Printer and FAX” to show the printer folder.

Supplement: In the case of Windows 2000, select “Start”, “Setting”, and “Printer”. If the “Printer and FAX” folder is not found, click the “Control Panel” and select “Printer and FAX”.
In the case of the category view, click the “Printer and Other Hardware” and select the “Printer and FAX”.

- (3) Select the “Add printer” from the File menu. The “Add Printer Wizard” is displayed.

- (4) Click the [Next] button in the “Add Printer Wizard”.

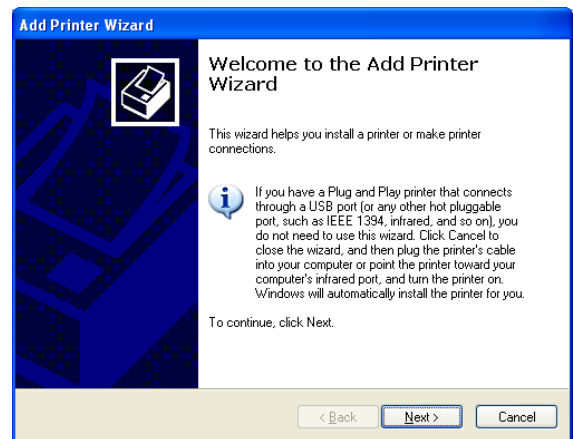

- (5) Select the “Local printer attached to this computer” and click the [Next] button.

Note: Do not check the “Automatically detect and install my Plug and Play printer” checkbox.

If you are installing a network printer, or a printer attached to another PC you must choose the local printer. This setting will be changed after the installation is completed. Even in the case of specifying the network printer or a printer connected to other PC, be sure to choose the local printer in this step. This setting is changed after the installation is completed.

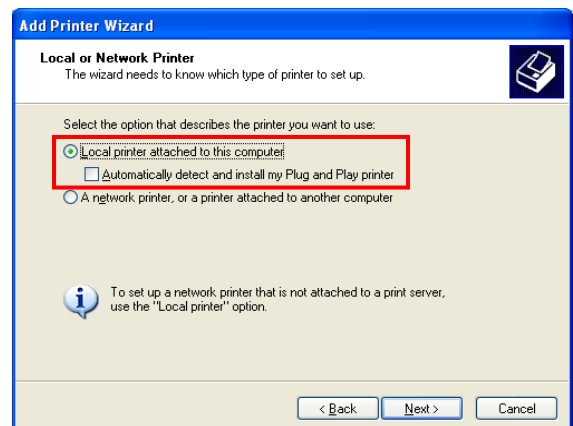

- (6) Specify a printer port and click the [Next] button.

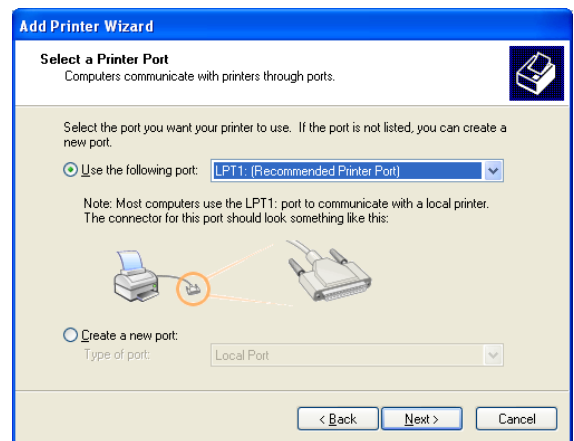

- (7) When the “Install Printer Software” screen appears, click the [Have Disk] button.

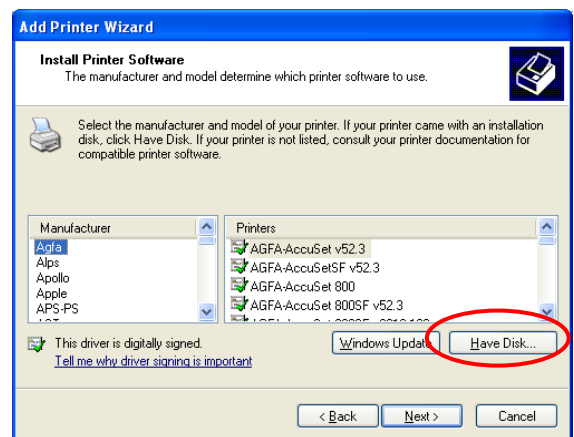

- (8) Specify the printer driver install folder (C:/TEC_DRV) created in **Section 2.7.4 Preparation for Installation**, and click the [Open] button. Select the “TOSHIBATEC.inf” and click the [OK] button.

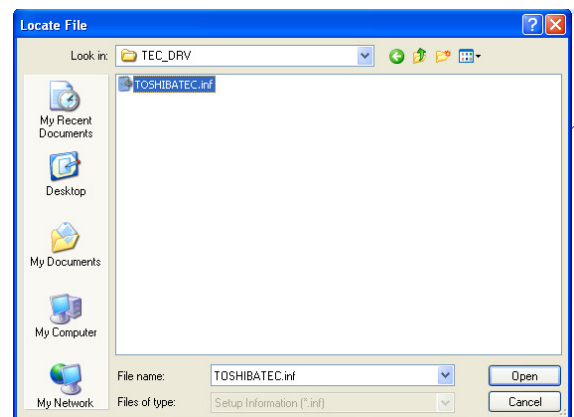

(9) The list of the installable printers is displayed.

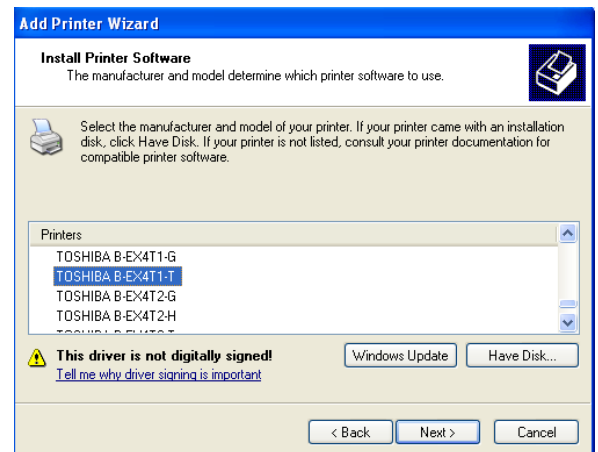

(10) Select the model to be installed, and click the [Next] button.
(Example: B-EX4T2-T)

(11) Select the “Replace existing driver”, and click the [Next] button.

Supplement: This step will be omitted when the printer driver is installed for the first time.

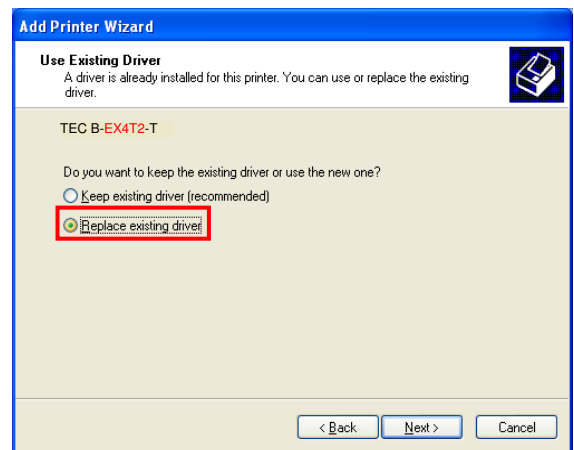

(12) Select whether or not to use the printer as a default printer, then click the [Next] button.

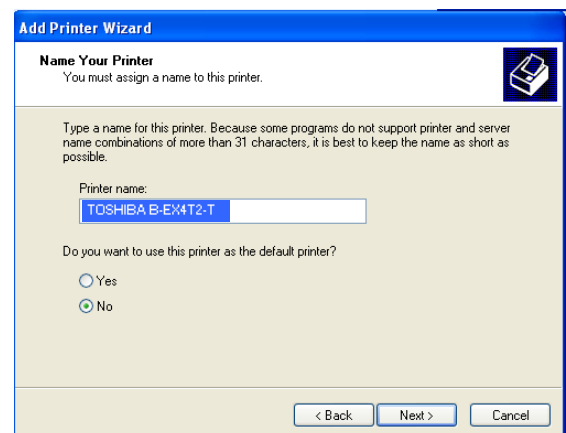

- (13) Select whether or not to share the printer with other users on the network, then click the [Next] button.

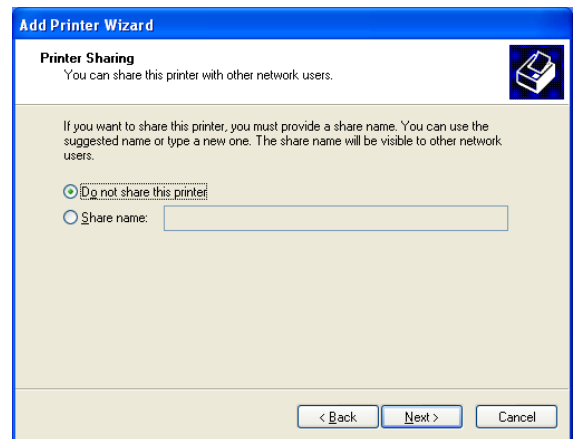

- (14) Select whether or not to perform a print test, then click the [Next] button.

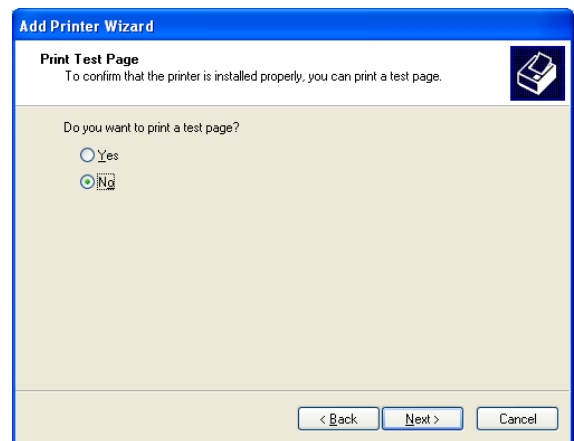

- (15) When the "Completing the Add Printer Wizard" is displayed, click the [Finish] button.

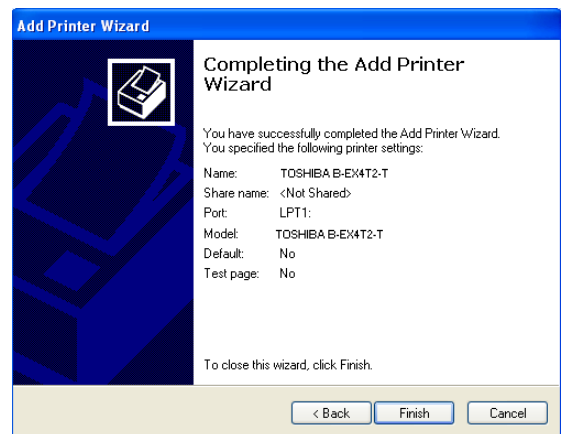

(16) When the screen on the right appears, click the [Continue Anyway] button.

Note: “Digital Signature Not Found” message may be displayed. In this case, click the [Yes] button.

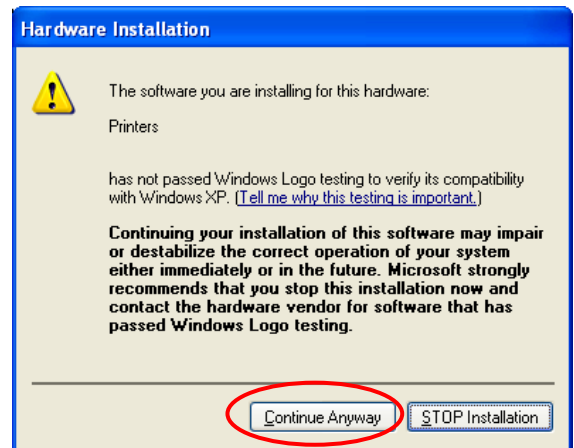

(17) Installation of the printer driver will start.

(18) When the installation is completed, a new printer icon will be added to the “Printer” folder.

2.7.6 Installation under Windows Vista/Server2008/7/Server2008R2

- (1) Turn on the PC.

Note: Log on as a user with administrative privilege.

- (2) Select “Start”, “Control Panel”, “Hardware and Sound”, and “Printer” to open the printer folder.

Supplement: Entering “Printer” in the Search box of the Start menu causes the “Printer” to be shown in the Program List.

- (3) Click the “Install a Printer” to start adding a printer.

- (4) Select the “Add a local printer”.

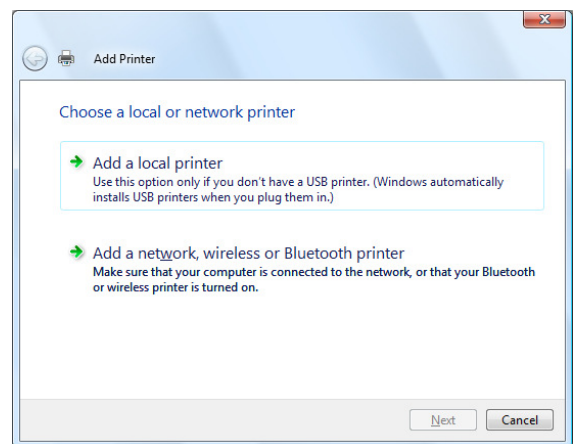

- (5) Select a printer port, and click the [Next] button.

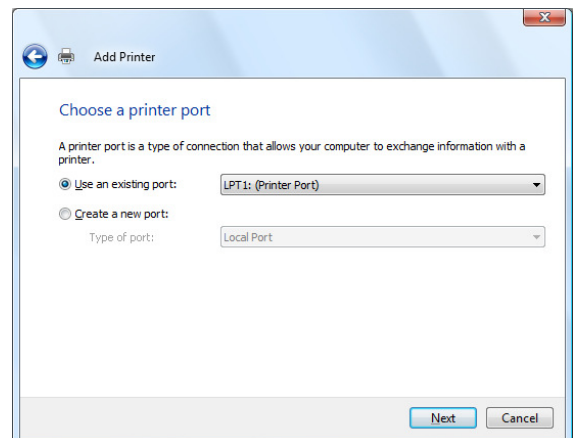

- (6) When the screen on the right appears, select “TOSHIBA TEC” from the Manufacturer list.

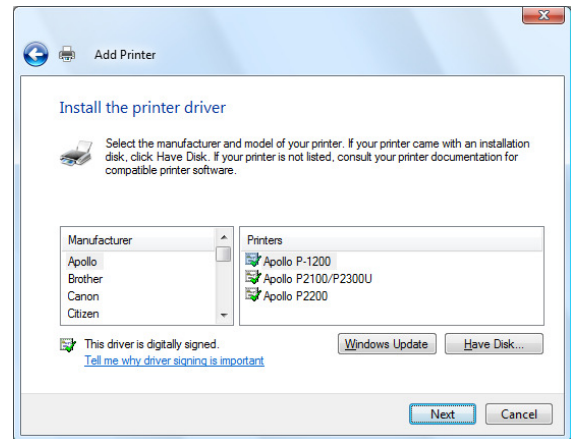

- (7) The list of the installable printer models is displayed.

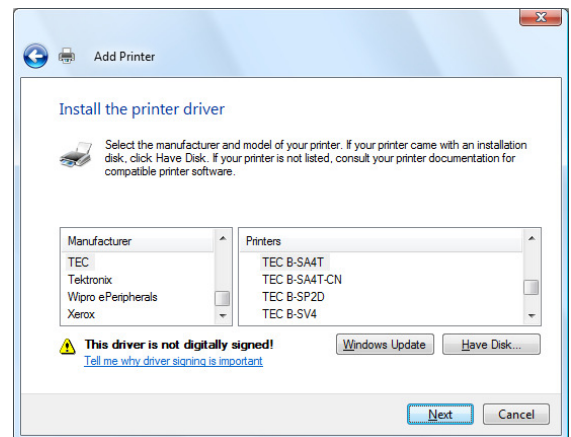

- (8) Select the model to be installed, then click the [Next] button.

- (9) Select the “Replace the current driver”, and click the [Next] button.

Supplement: This step will be omitted when the printer driver is installed for the first time.

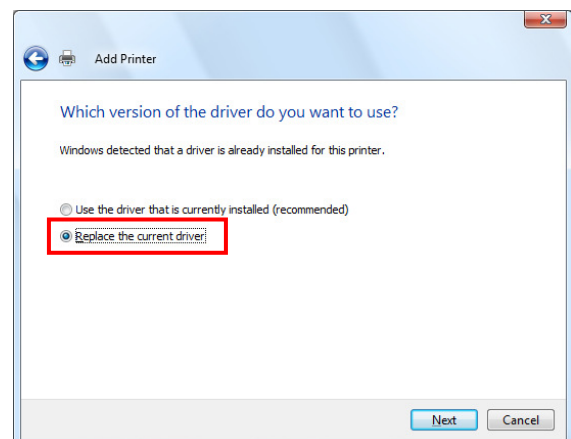

- (10) Select whether or not to use the printer as a default printer, then click the [Next] button.

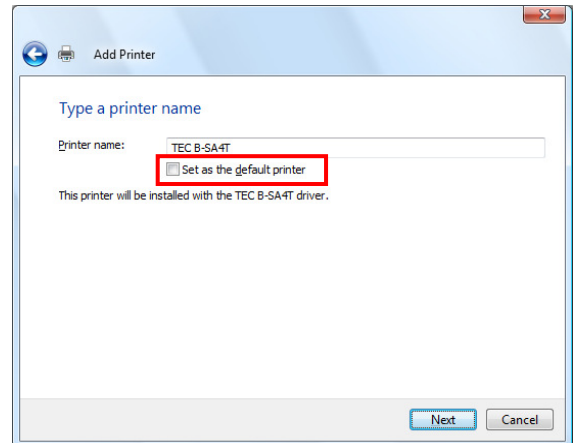

- (11) Installation will start.

- (12) When the installation is completed, the “Add Printer” screen is displayed. At this time, a new printer icon is added to the “Printer” folder. Click the [Finish] button. If you want to perform a print test, click the [Print a test page] button.

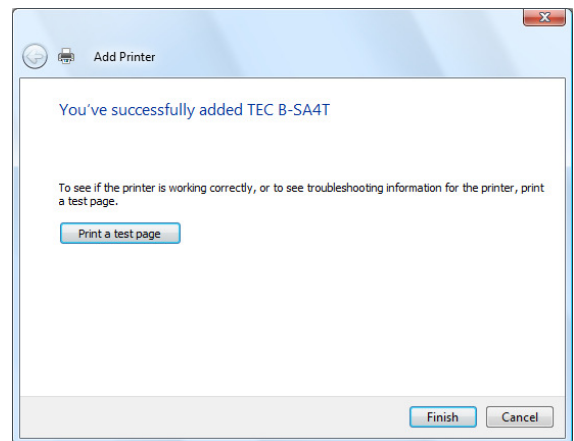

2.7.7 Installation under Windows 2000 (USB with Plug & Play Enabled)

- (1) Turn on the PC.

Note: Log on as a user with administrative privilege.

- (2) Turn on the printer and connect it to the PC with a USB cable.

- (3) "USB DEVICE" is detected and "USB Print support" is automatically installed.

- (4) The "Found New Hardware Wizard" will be displayed. (This may not appear immediately.)
Click the [Next] button.



- (5) Select the "Search for a suitable driver for my device (recommended)", and click the [Next] button.

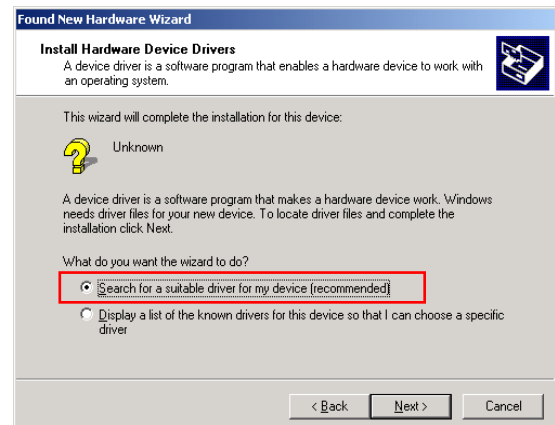

- (6) Check the "Specify a location" checkbox, then click the [Next] button.



- (7) Click the [Browse] button. Specify the folder (C:\TEC_DRV) created in **Section 2.7.4**, and click the [Next] button.



- (8) Make sure the driver of this device has been detected, then click the [Next] button.

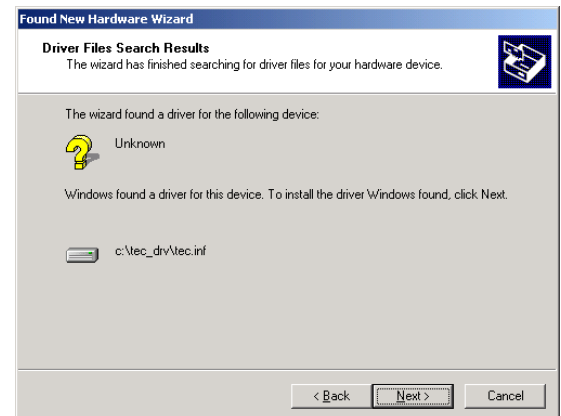

- (9) When the screen on the right is displayed, click the [Yes] button.

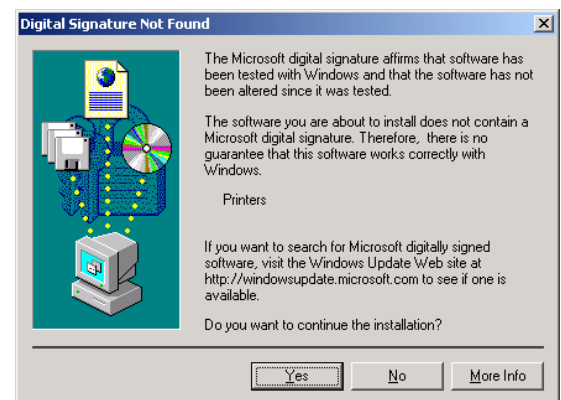

- (10) When “Completing the Found New Hardware Wizard” is displayed, click the [Finish] button.

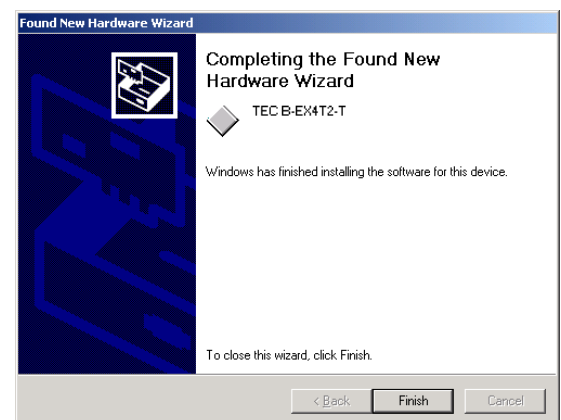

- (11) When the installation is completed, a new printer icon is added to the Printer folder.

2.7.8 Installation under Windows XP/Server2003 (USB with Plug & Play enabled)

- (1) Turn on the PC.

Note: Log on as a user with administrative privilege.

- (2) Turn on the printer, and connect it to the PC with a USB cable.

- (3) "USB DEVICE" is detected, and the "USB Print Support" is automatically installed.

- (4) The device will automatically be detected.

- (5) When "Found New Hardware Wizard" is displayed, select "Install from a list or specific location [Advanced]" and click the [Next] button.

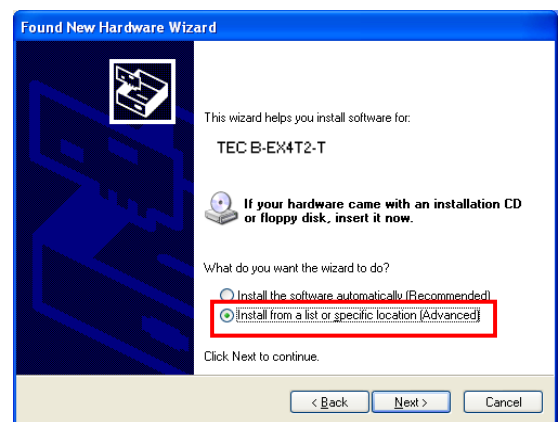

- (6) Select the "Search for the best driver in these locations". Check the "Include this location in the search" checkbox, and click the [Browse] button.

Specify the folder (C:\TEC_DRV) created in **Section 2.7.4**, and click the [Next] button.

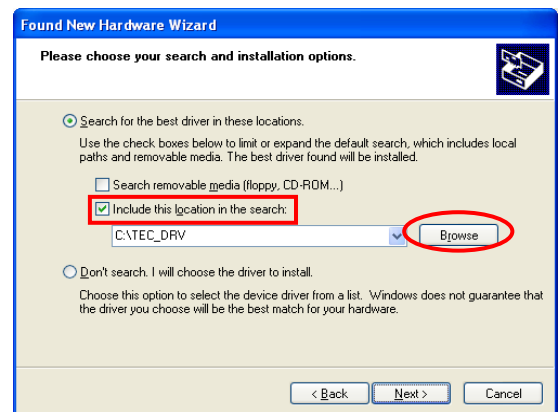

- (7) When the screen on the right appears, click the [Continue Anyway] button.



- (8) When “Completing the Found New Hardware Wizard” is displayed, click the [Finish] button.

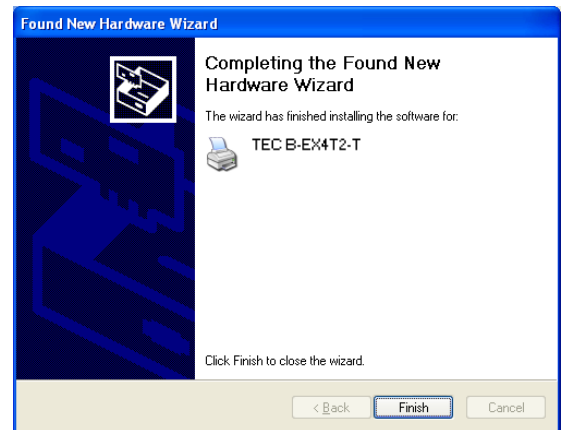

- (9) When the installation is completed, a new printer icon is added to the Printer folder.

2.7.9 Installation under Windows Vista/Server 2008/7/Server2008R2 (USB with Plug & Play Enabled)

- (1) Turn on the PC.

Note: Log on as a user with administrative privilege.

- (2) Turn on the printer and connect it to the PC with a USB cable.

- (3) Installation of the device driver software is automatically started.

- (4) After a short time, the printer driver installation will be completed.

- (5) When the installation is completed, a new printer icon is added to the Printer folder.

2.7.10 Uninstalling the Printer Driver

1) To delete the printer drivers except for V6.5 Build75 and V6.5 Build77

In the following cases, be sure to uninstall the printer driver using the procedure below.

- When the same version is going to be re-installed.
- When an older version has been already installed.
- When the installation is canceled before being completed, or when the [No] is selected at a confirmation of the digital signature.
- When the printer driver cannot be installed for some reason.

Notes: 1. When installing the printer driver with Plug & Play enabled, turn OFF the printer first.

2. When the printer driver is deleted, the information for any registered stocks and bar codes will also be deleted. This information can be saved in a file, before beginning this process, by using the export function, and restored by using the import function after re-installation of the printer driver.

● Deleting the printer drivers except for V7.2 M-2

Before deleting the printer driver, except for V7.2 M-2, follow the procedure described in **Section 2.7.4 Preparation for Installation**. Doing this causes the previously installed printer driver to be updated and creates a shortcut of the Driver Wizard in the TPCL Printer Driver of TOSHIBA TEC folder.

It is not possible to update a printer driver which is older than V6.9.3 M-0. For such versions, first delete the "C:\TEC_DRV" folder, then perform the Preparation for Installation procedure. When the preparation is completed, the shortcut of the "Driver Wizard" is created in the TPCL Printer Driver folder.

● How to uninstall the printer driver

- (1) Select the "Start", "All programs", "TOSHIBA TEC", "TPCL Printer Driver", and "Driver Wizard".

Note: Log on as a user with administrative privilege.

Exit all Windows applications before performing the above operation. Confirm that there are no print jobs in the spooler, then close the spooler and the printer folder.

In the case of Windows Vista/Server 2008/7/Server2008R2, the User Account Control screen may appear. In this case, click [Allow].

- (2) Select the "Remove printer drivers", and click the [Next] button.

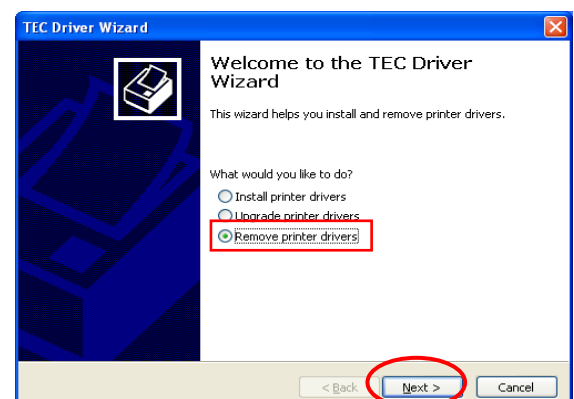
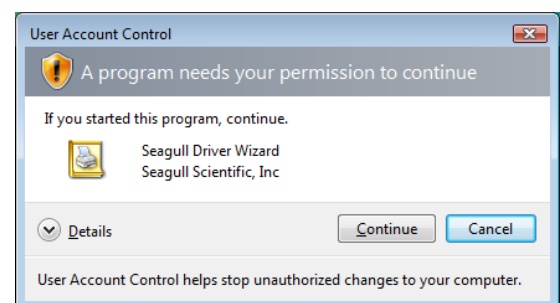

- (3) Select the “Automatically remove all TEC Printer Drivers”, and click the [Next] button.

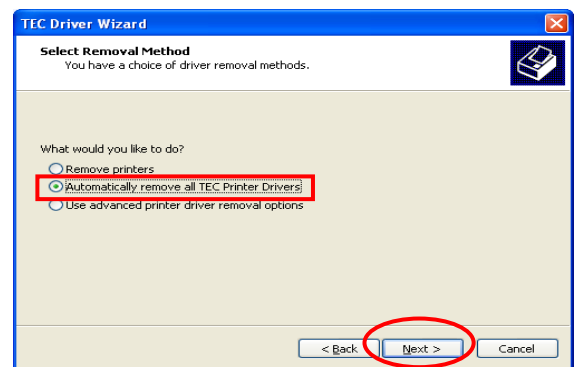

- (4) Click the [Finish] button to start to delete the printer drivers.

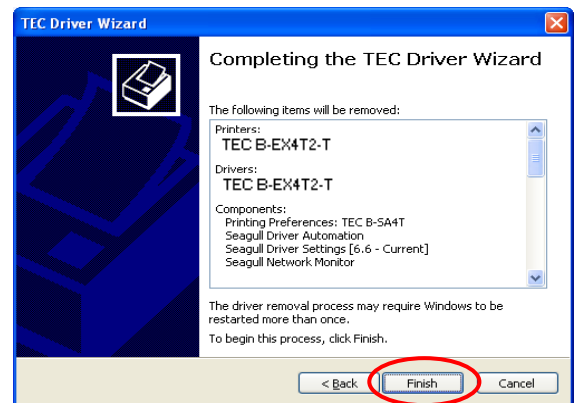

- (5) When the “Restart System” screen is displayed, click the [Restart] button.

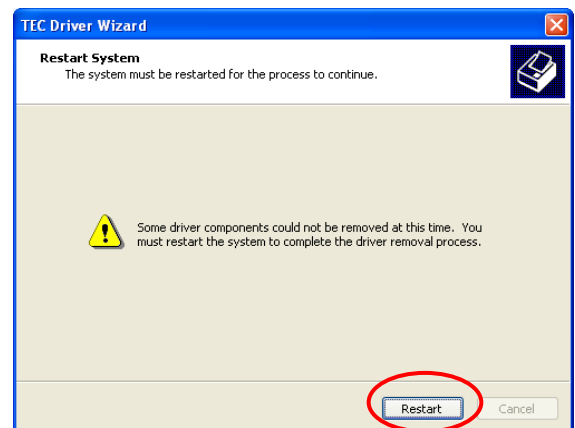

- (6) When the printer driver is deleted successfully, the screen on the right is displayed.

Note: If the deletion of the printer driver failed, retry from Steps 1 to 5 until the deletion succeeds.

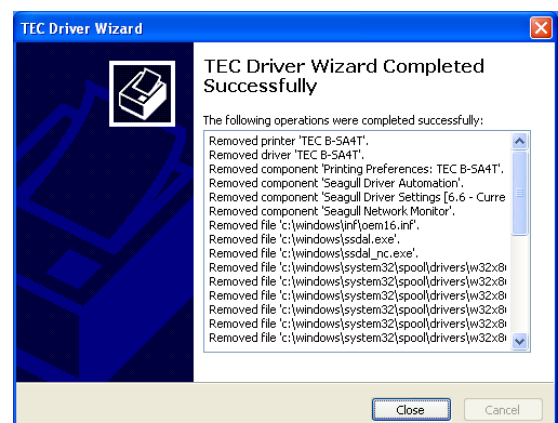

Note: *In the case that a network printer has been installed in multiple user accounts under Windows Vista/server 2008/7/Server2008R2, it is not possible to delete the printer driver. You must first, delete the printer icon from each user account, then delete the printer driver.*

● **Deleting the setup information configured during the preparation**

- (1) Select the “Start”, “Control Panel”, and “Add/Remove Programs”.

Note: *Log on as a user with administrative privilege.*

- (2) Select the “TPCL Printer Driver Vx.x (version)” or “TEC Printer Driver Install file” from the list, then click the [Delete] button.
- (3) When the confirmation message is displayed, click the [Yes] button.
- (4) When the “Uninstall completed” screen appears, click the [Finish] button.

2) To delete the V6.5 Build75 or V6.5 Build77

- (1) Select the “Start”, “Control Panel”, and “Add/Remove Programs”.

Note: *Log on as a user with administrative privilege.*

- (2) Select the “TEC **** printer” from the “Edit/Remove Programs”, and click the [Add and delete]. (**** indicates a printer model name. For example, B-EX4T1-T, etc.)
- (3) Confirm that the selected file in the “File Delete confirmation” window is correct, then click the [Yes] button.
- (4) When “Uninstall completed” is displayed, click the [OK] button.

Note: *If you deleted the printer icon without performing Steps 1 to 4 above, delete the setup information through the “Add/Remove Programs” after re-installing the printer driver.*

- (5) When the deletion is completed, reboot the PC.

2.8 Print Test

After your operating environment has been set, perform a print test.

1. Perform a print test by using the Printer Driver or an Issue Command.

The printer driver's Properties screen allows you to set the communication conditions, media size, and other printing conditions in accordance with your operating environment. For details, refer to the **Help for the Windows Printer Drivers** screen.

Example: Stock tab display of the Printer Driver's Properties Screen

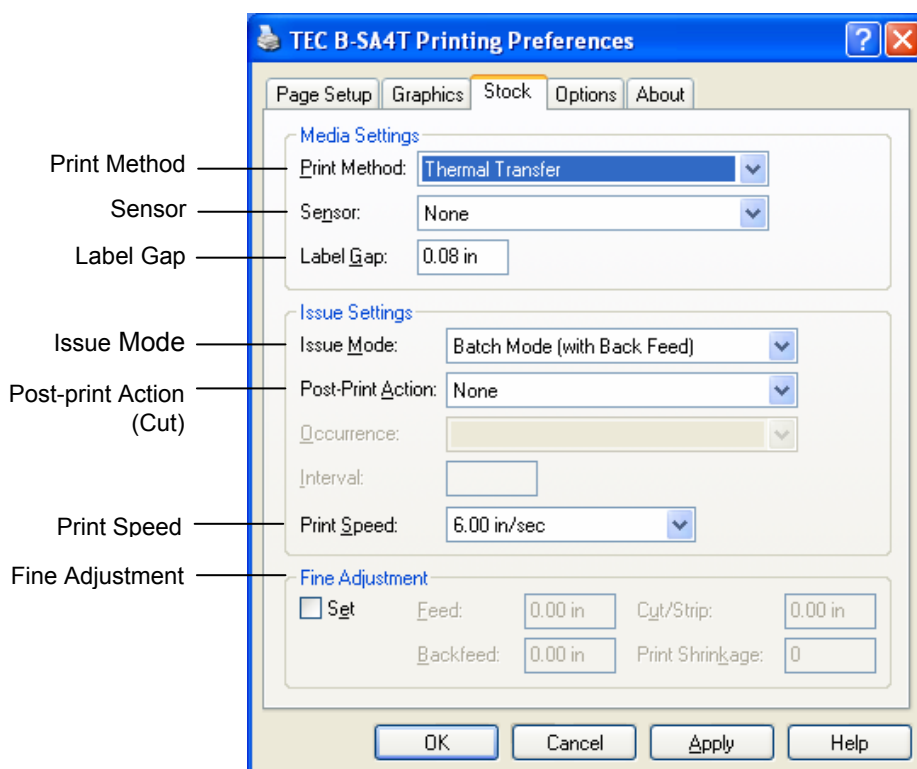

Print Method: Direct thermal or thermal transfer is selectable.

Sensor: Media sensor type is selectable.

Issue Mode: Batch, strip or cut is selectable.

Post-print Action: Whether to use the cutter or not is selectable.

Fine Adjustment: Adjustment values for the feed amount, cut/strip position, etc. can be set.

2. Confirm the print test result.

- When a print start position, cut/strip position, or print tone needs to be adjusted: ⇒ **Section 2.9 Position and Print Tone Fine Adjustment**
- When pre-printed media is used, and if a print start position is not properly detected: ⇒ **Section 2.10 Threshold Setting**

2.8 Print Test (Cont.)

■ When using a Strip Module or an optional Cutter Module

It is necessary to set the issue mode, cut/strip position, etc. on the Printer Driver or with TPCL (TEC Printer Command Language) in accordance with your printing condition.

For details of the TPCL, refer to the **B-EX4T/EX6T Series External Equipment Interface Specification**.

Regarding how to use the Printer Driver, refer to the **Help for the Windows Printer Drivers** screen.

To gain maximum performance and life from the Cutter Module or Strip Module, periodic cleaning is required.

Before starting a cleaning, be sure to TURN OFF the printer to avoid risk of injury.

For details of cleaning, refer to **Section 4.1.3 Optional Cutter Module**.

2.9 Position and Print Tone Fine Adjustment

This section describes how to fine adjust a print start position, cut/strip position, reverse feed amount, print tone, and ribbon motor torque.

When a fine adjustment is required, follow the procedure below.

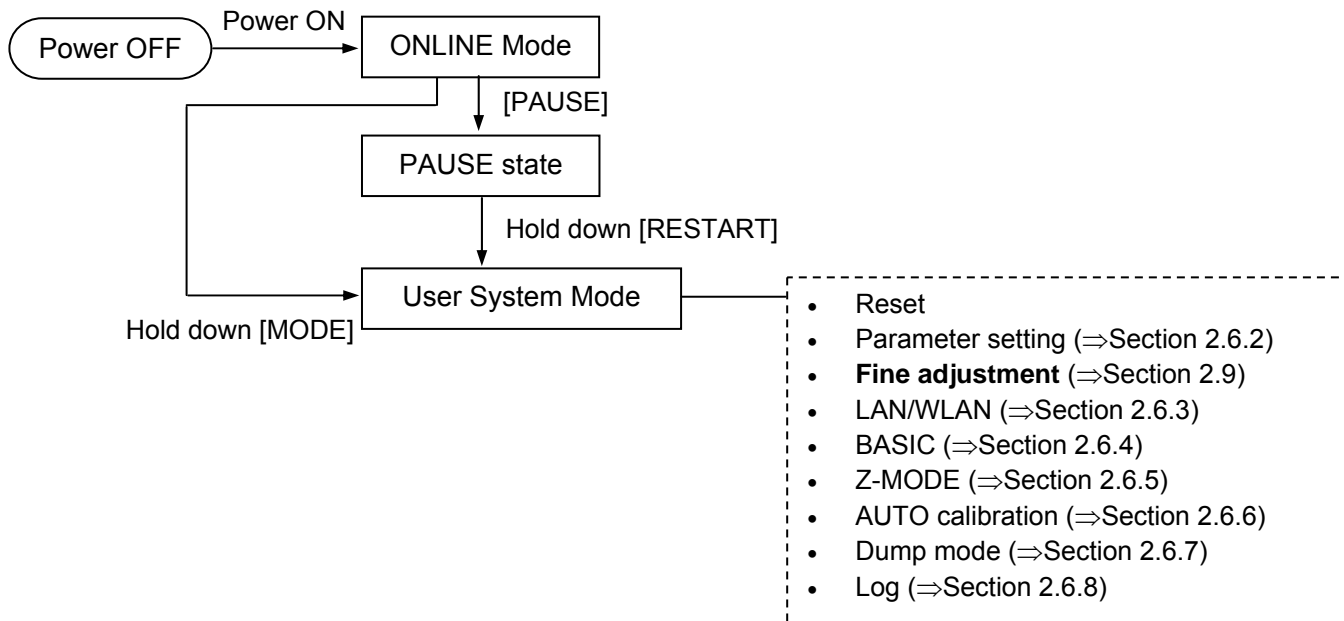

2.9.1 Fine Adjustment

USER SYSTEM MODE

| | |
|---|------------------|
| ▲ | <1>RESET |
| □ | <2>PARAMETER SET |
| ■ | <3>ADJUST SET |
| ▼ | <4>LAN/WLAN |

Contents of the Fine Adjustment Menu

| Menu | Parameter | |
|--------------------|---|---|
| Adjust set | FEED ADJ. | Adjusts the feed amount to the print start position |
| | CUT ADJ. | Adjusts the cut or strip position. |
| | BACK ADJ. | Adjusts the reverse feed amount. |
| | X ADJUST | Adjusts the print position in X coordinate (horizontal direction) |
| | TONE ADJ. (TRANS.) | Adjusts the print tone for thermal transfer printing. |
| | TONE ADJ. (DIRECT) | Adjusts the print tone for direct thermal printing. |
| | RBN ADJ. <FW> | Adjusts the ribbon take-up motor drive voltage. |
| | RBN ADJ. <BK> | Adjusts the ribbon feed motor drive voltage. |
| | THRESHOLD <REFL.> | Sets a fine adjustment value for the threshold for the reflective sensor. |
| THRESHOLD <TRANS.> | Sets a fine adjustment value for the threshold for the transmissive sensor. | |

NOTE:

The printer driver's properties screen also has Parameter Fine Adjustment menu.

2.9.1 Fine Adjustment (Cont.)

(1) FEED ADJ.

Print start position is shifted by fine adjusting the feed amount.

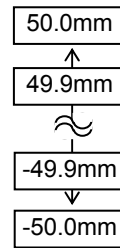

• Example of Print Start Position Fine Adjustment

When setting +3.0 mm

Compared with “+0.0mm” position, the print start position is shifted forward.

When setting +0.0 mm

When setting -3.0 mm

Compared with “+0.0mm” position, the print start position is shifted backward.

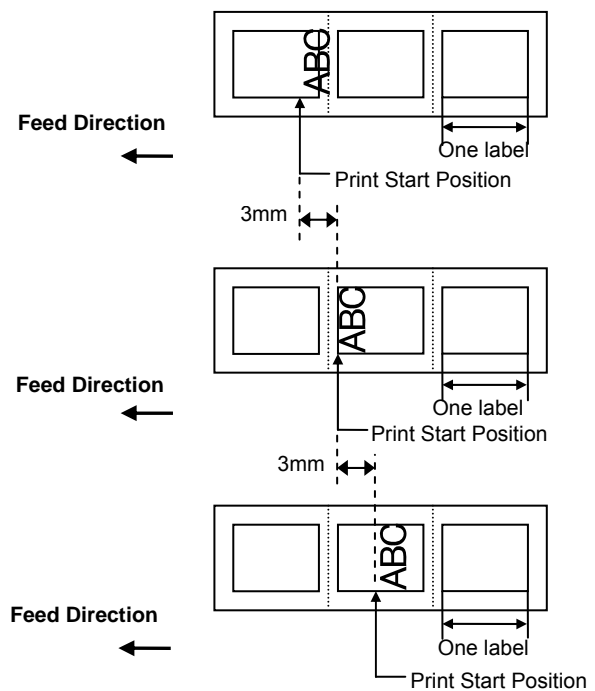

NOTE:

Do not set the fine adjustment value which is larger than the media pitch. When the set value exceeds the media pitch, the printer operation is not guaranteed.

2.9.1 Fine Adjustment (Cont.)

(2) CUT ADJ.

Cut position or peel-off position is shifted by fine adjusting the feed amount.

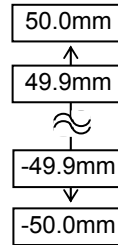

• Example of Cut Position Fine Adjustment

When setting +3.0 mm

Compared with “+0.0mm” position, the cut position is shifted forward.

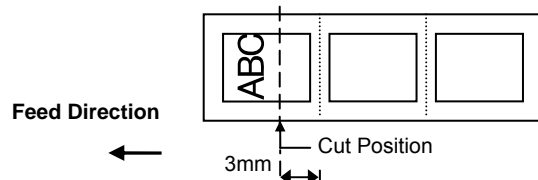

When setting +0.0 mm

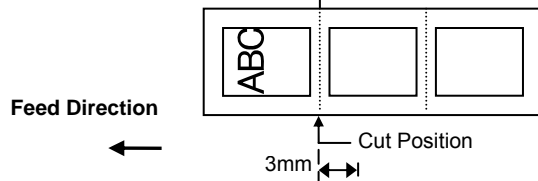

When setting -3.0 mm

Compared with “+0.0mm” position, the cut position is shifted backward.

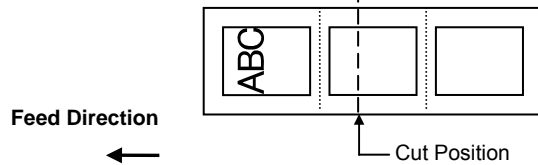

• Example of Peel-off Position Fine Adjustment

When setting +3.0 mm

Compared with “+0.0mm” position, the peel-off position is shifted forward.

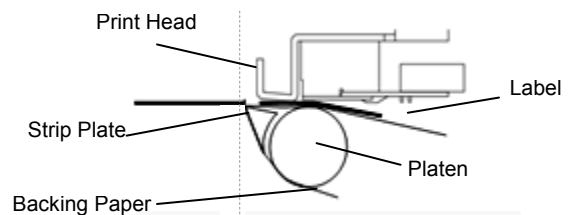

When setting +0.0 mm

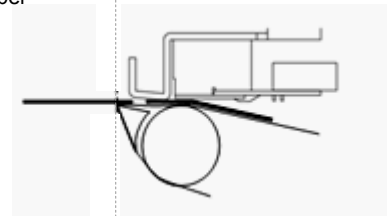

When setting -3.0 mm

Compared with “+0.0mm” position, the peel-off position is shifted backward.

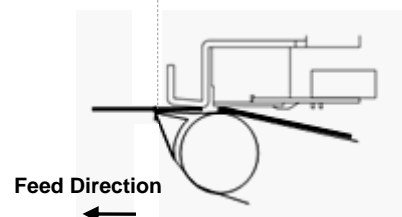

2.9.1 Fine Adjustment (Cont.)

(3) BACK ADJ.

Reverse feed amount to the next print start position is fine adjusted.

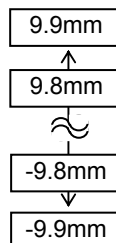

• Example of Reverse Feed Amount Fine Adjustment

When setting +3.0 mm

Compared with “+0.0mm” position, the print start position after a reverse feed is shifted forward.

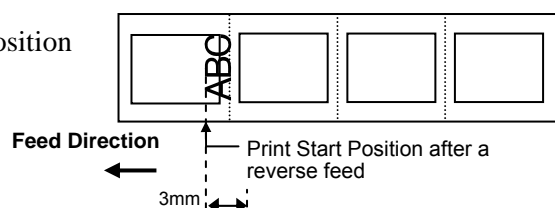

When setting +0.0 mm

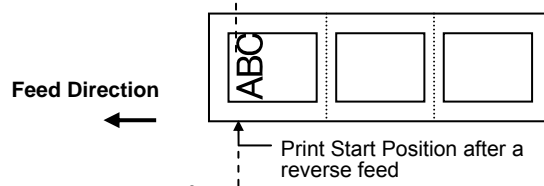

When setting -3.0 mm

Compared with “+0.0mm” position, the print start position after a reverse feed is shifted backward.

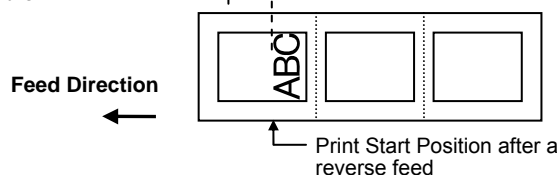

NOTE:

Depending on the print conditions, a label may not return to the home position with a reverse feed, even if a reverse feed amount is specified to the same length as the forward feed.

On the following conditions, the media may not return to the home position, resulting in an error.

- The media sensor is used.
- The media pitch is almost the same as the distance between the print head and the media sensors (75.5 mm.)
- A printer action includes a reverse feed (such as cut issues, strip issues, and automatic forward feed standby.)

To prevent an error from occurring, the reverse feed amount needs to be increased by performing the back feed fine adjustment in the positive (+) direction.

2.9.1 Fine Adjustment (Cont.)

(4) X ADJUST

Print position in X-coordinate (horizontal direction) is fine adjusted.

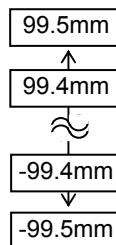

• Example of X Coordinate Fine Adjustment

When setting -50.0 mm

Compared with “+0.0mm” position, the print position is shifted to the left.

When setting +0.0 mm

When setting +50.0 mm

Compared with “+0.0mm” position, the print position is shifted to the right.

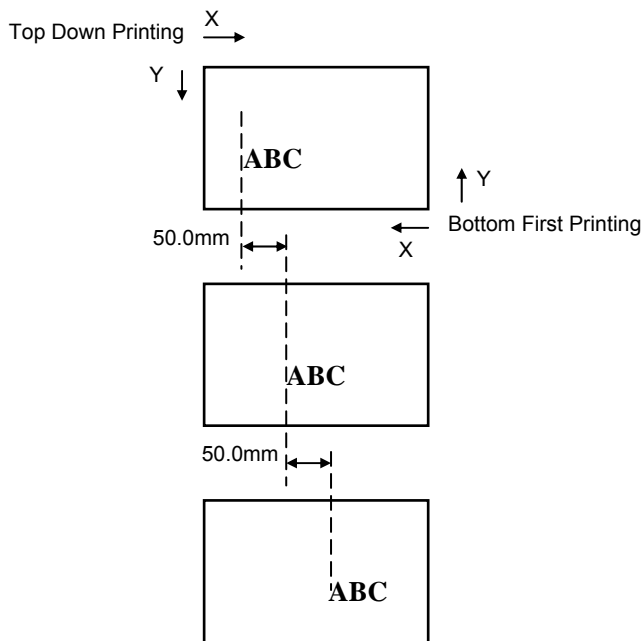

2.9.1 Fine Adjustment (Cont.)

(5) TONE ADJ.(TRANS.)

Print tone for the thermal transfer printing is fine adjusted.

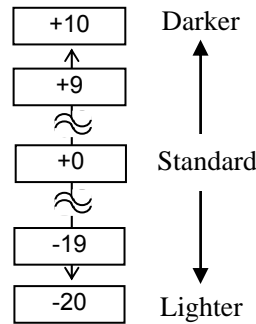

(6) TONE ADJ.(DIRECT.)

Print tone for the direct thermal printing is fine adjusted.

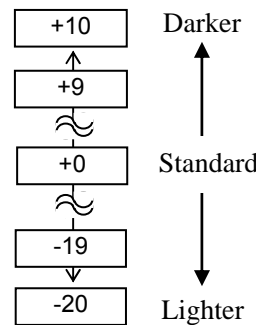

(7) RBN ADJ.<FW>

When the ribbon is slack or wrinkled and printing is affected, fine adjust the ribbon motor torque.

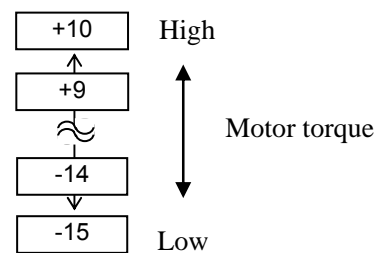

NOTE:

1. The fine adjustment value is not effective for the reverse rotation.
2. The fine adjustment value is limited depending on the print speed.

| Value | Print speed |
|-----------|---------------|
| -15 to 0 | All speed |
| +1 to +5 | 8 ips or less |
| +6 to +10 | 6 ips or less |

2.9.1 Fine Adjustment (Cont.)

NOTE:

1. The fine adjustment value is not effective for the reverse rotation.
2. The all fine adjustment values are applicable to every print speed.

(8) RBN ADJ.<BK>

When the ribbon is slack or wrinkled and printing is affected, fine adjust the ribbon motor torque.

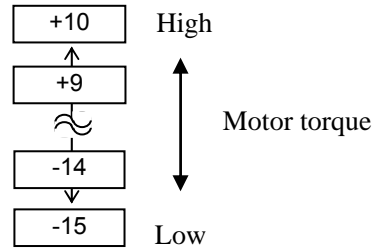

(9) THRESHOLD <REFL.>

When you perform a threshold setting for the reflective sensor and found the threshold needs to be adjusted, set a fine adjustment value.

This menu is accessible directly from the Threshold Setting Mode so that the threshold can be manually set right away.

Manually set threshold = Peak voltage – The value set here
For details, refer to **Section 2.10**.

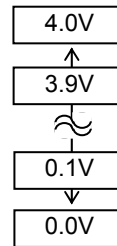

NOTE:

When “0.0 V” is set for this parameter, it is automatically corrected to 1.0V (default) after the power is turned OFF then ON.

(10) THRESHOLD <TRANS.>

When you perform a threshold setting for the Transmissive sensor and found the threshold needs to be adjusted, set a fine adjustment value. This menu is accessible directly from the Threshold Setting Mode so that the threshold can be manually set right away.

Manually set threshold = Peak voltage – The value set here
For details, refer to **Section 2.10**.

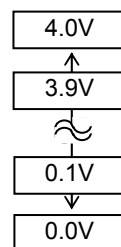

NOTE:

When “0.0 V” is set for this parameter, it is automatically corrected to 1.4V (default) after the power is turned OFF then ON.

2.10 Threshold Setting

To maintain a constant print position the printer uses the media sensor to detect a print start position according to the difference of voltage between a print area and a gap or black mark. When the media is pre-printed, the darker (or more dense) inks can interfere with this process causing paper jam errors.

To get around this problem, first, try an automatic threshold setting.

If the problem still occurs, then, the threshold voltage needs to be fine adjusted.

Threshold is a voltage level by which the printer determines whether a print area or a gap/a black mark is being detected by the media sensor.

The threshold is a boundary between a print area and a gap/black mark, and should be a midpoint of their voltage levels.

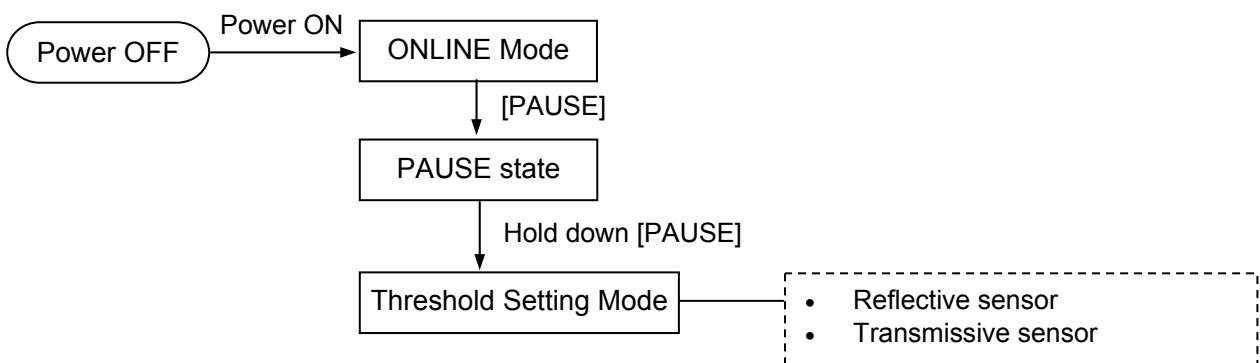

- (1) Load the media to be used.
- (2) Choose 1) or 2) depending on the sensor type to be used, then press the [ENTER].

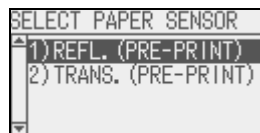

NOTES:

1. Failure to feed more than 1.5 labels may result in an incorrect threshold setting.
2. Ensure that a paper end or ribbon end error will not occur during paper feed.

- (3) Hold down the [PAUSE] until more than 1.5 labels (tags) have been fed.
The media will continue to be fed until the [PAUSE] is released. (An automatic threshold setting for the selected sensor is completed by this operation.)

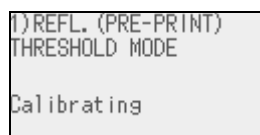

- (4) The result of the threshold setting is displayed.

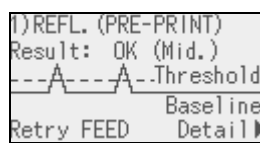

(e.g.: Succeeded)

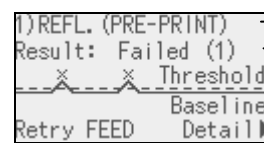







(e.g: Failed)

- Sensor type
- Result (Text)
- Result (Graph)
- Key operation guide

2.10 Threshold Setting (Cont.)

NOTE:
 To make a threshold value set in this section effective, select the *Transmissive Sensor* (when using pre-printed media) or *Reflective Sensor* (when using manual threshold value) in *Issue Command* or the printer driver.

| | Display example | Explanation |
|---|---|---|
| 1 |  | Result: OK (Mid.) Threshold is at the midpoint between the peak and the baseline. |
| 2 |  | Result: OK (High) Threshold is near the peak voltage, so detection of a gap/black mark may fail if the voltage difference is very small. Adjusting the threshold to the midpoint between the peak and the baseline enables more accurate detection. Follow next (5) to (10) |
| 3 |  | Result: OK (Low) Threshold is near the baseline voltage, so detection of a gap/black mark may fail if the voltage difference is very small. Adjusting the threshold to the midpoint between the peak and the baseline enables more accurate detection. Follow next (5) to (10) |
| 4 |  | Failed (1) The media sensor cannot detect a gap/black mark. Sensor adjustment is required. (⇒Section 2.11) |
| 5 |  | Failed (1) The media sensor cannot detect a gap/black mark. (Threshold ≤ Baseline) Sensor adjustment is required. (⇒Section 2.11) |
| 6 |  | Failed (2) Detection by the media sensor is disabled. Sensor adjustment is required. (⇒Section 2.11) |

- (5) To return to the sensor selection screen, press the [FEED].
 To terminate the threshold setting, press the [ENTER].
 To see the details, press the [RIGHT].

```
(1)REFL. (PRE-PRINT)
Peak      : 3.7V
Threshold : 2.7V
Baseline  : 1.3V
◀Result  Adjust▶
```

(e.g.: Succeeded)

```
(1)REFL. (PRE-PRINT)
Peak      : 2.1V
Threshold : 1.3V
Baseline  : 1.2V
◀Result
```

(e.g.: Failed)

- Sensor type
- Peak voltage
- Threshold voltage
- Baseline voltage
- Key operation guide

2.10 Threshold Setting (Cont.)

NOTE:

The threshold can be manually set as follows:
 Manually set threshold = Peak voltage – Threshold fine adjustment value
 e.g.) When Peak=3.5V and Fine adjustment value=1.0V, the threshold will be set to 2.5V.

- (6) To return to the previous display, press the [LEFT].
 To set a fine adjustment value, press the [RIGHT]. The threshold fine adjustment screen in ADJUST SET menu appears.
 Set a value and press the [ENTER], [PAUSE] or [CANCEL].

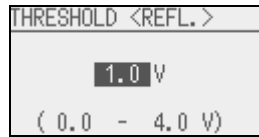

- (7) The result after manually setting the threshold is displayed.

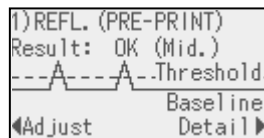

To set a fine adjustment value, press the [LEFT].
 To return to the sensor selection screen, press the [FEED].
 To terminate the threshold setting, press the [ENTER]. The printer is placed in Pause state.

- (8) After the threshold is properly set, exit the threshold setting mode and place the printer in the user system mode to set the Threshold select parameter to Manual Set for the applicable sensor.
 For details, refer to **Section 2.6.2.2 Software Set**.

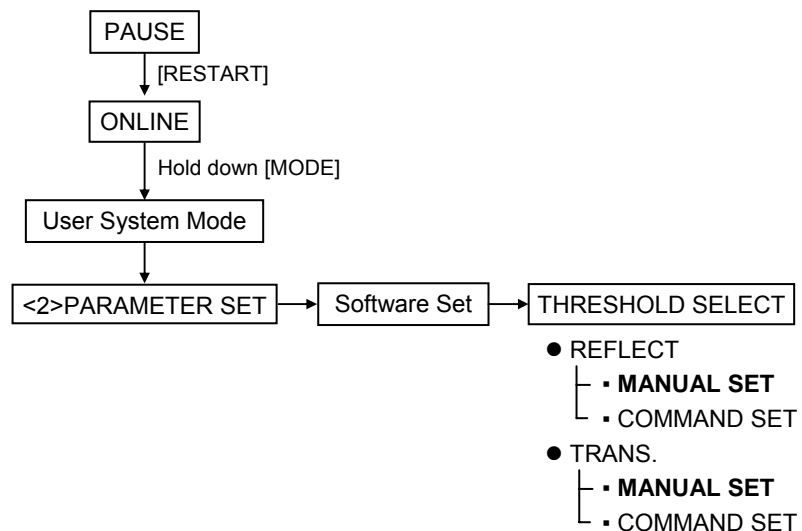

- (9) Return to the User System Mode menu by pressing the [MODE].
 Choose <1>RESET and press the [ENTER] to reset the printer.
- (10) When the printer is placed in the online mode, press the [FEED] to feed the media.
 If a paper jam occurs or the media does not stop at the print start position, retry the threshold setting.

2.11 Sensor Setting

If a paper jam error still occurs even after a threshold setting has been performed, register the voltage level of media to the media sensor.

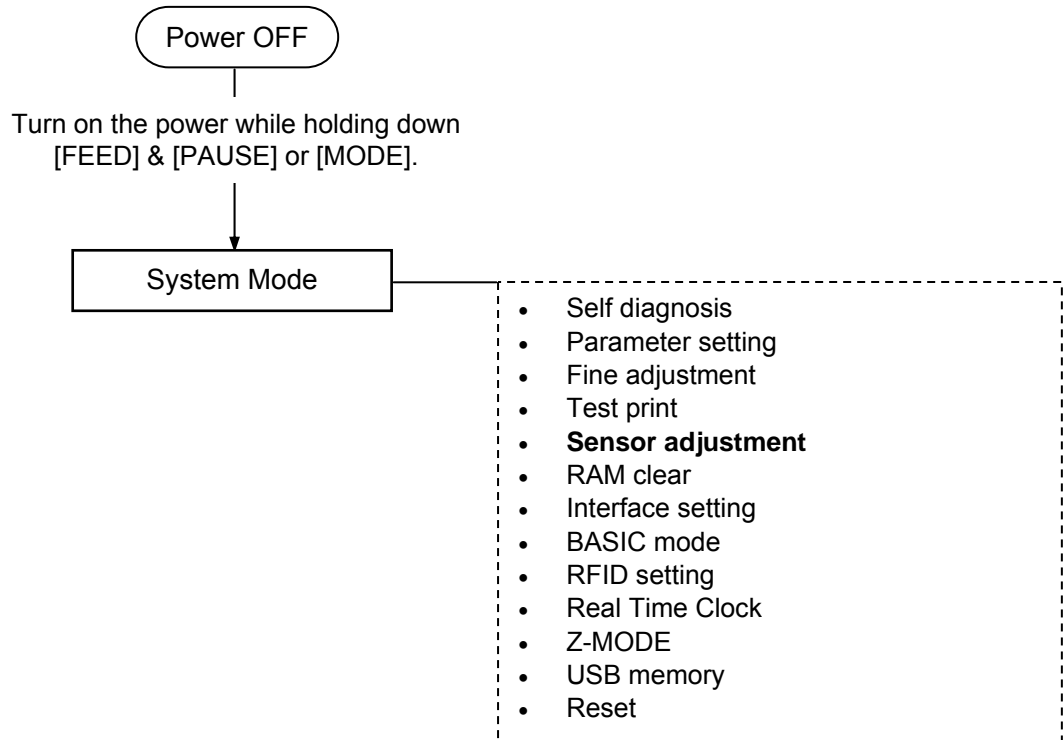

SYSTEM MODE

| | |
|---|--------------------------|
| ▲ | <3>ADJUST SET |
| □ | <4>TEST PRINT |
| ■ | <5> SENSOR ADJUST |
| ▼ | <6>RAM CLEAR |

Contents of the Sensor Adjust Menu

| Menu | Parameter | |
|---------------|-----------------|---|
| Sensor Adjust | TEMPERATURE | Displays the ambient temperature and print head temperature. |
| | REFLECT | Registers the voltage level of tag paper's print area to the reflective sensor. |
| | TRANS. | Registers the voltage level of label gap to the transmissive sensor. |
| | PE REFL./TRANS. | Registers the voltage level of no paper to the reflective/transmissive sensor. |
| | RIBBON | Registers the voltage level of ribbon to the ribbon end sensor. |

2.11 Sensor Setting (Cont.)

(1) REFLECT

1. Select "REFLECT" from the Sensor Adjust menu.
2. Place the tag paper to be used on the reflective sensor so that the sensor can detect a print area.
3. Hold down the [ENTER] for 3 seconds or more.
4. When registration of the "print area level" is completed, "Adjust Complete" is displayed and an asterisk is shown on the right side of the voltage.

(2) TRANS.

1. Select "TRANS." from the Sensor Adjust menu.
2. Remove some labels and place the backing paper so that the Transmissive sensor can detect it.
3. Hold down the [ENTER] for 3 seconds or more.
4. When registration of the "label gap level" is completed, "Adjust Complete" is displayed and an asterisk is shown on the right side of the voltage.

(3) PE REFL./TRANS.

1. Select "PE REFL./TRANS." from the Sensor Adjust menu.
2. Remove any media from the media sensor.
3. Hold down the [ENTER] for 3 seconds or more.
4. When registration of the "no media level" is completed, "Adjust Complete" is displayed and an asterisk is shown on the right side of the voltage.

3. ONLINE MODE

This chapter describes the usage of the keys on the Operation Panel in Online mode.

When the printer is in Online mode and connected to a host computer, the normal operation of printing on labels or tags can be accomplished.

3.1 Key Functions

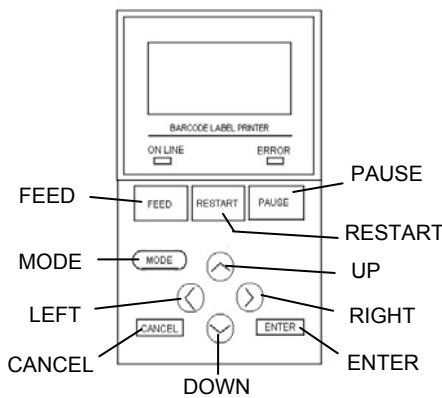

■ Key functions in the online mode

| Key | Function |
|-----------|--|
| [FEED] | (1) Feeds the set media length. (2) Prints the data in the image buffer according to the system mode setting. (3) Clears the help message. |
| [RESTART] | (1) Resumes printing after a temporary pause in printing or after an error. (2) Places the printer in the initial state which is obtained when the power is turned on. (3) Places the printer in the user system mode. (4) Clears the help message. |
| [PAUSE] | (1) Stops label printing temporarily. (2) Programs the threshold values. (3) Clears the help message. |
| [MODE] | (1) Places the printer in the user system mode. (2) Clears the help message. |
| [CANCEL] | (1) Clears the job. (2) Displays previous help message page. |
| [ENTER] | (1) Displays next help message page. (2) Clears the help message. |
| [UP] | (1) Scrolls up |
| [DOWN] | (1) Scrolls down |
| [LEFT] | (1) Displays previous help message page. |
| [RIGHT] | (1) Displays next help message page. |

3.2 LCD

Online state

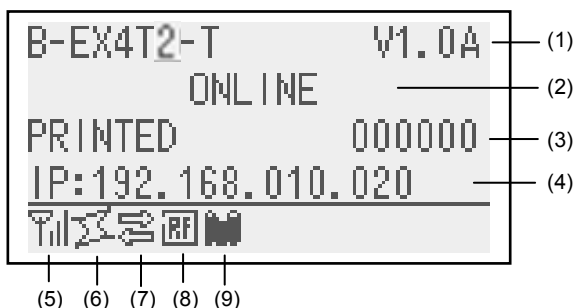

Error state

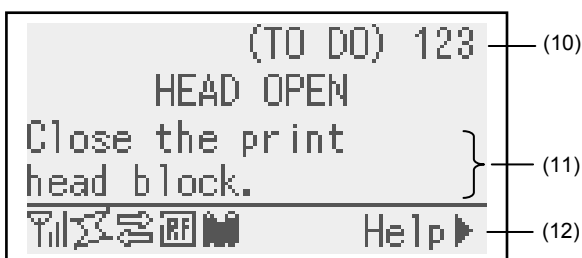

(Example: Head open error)

| No. | Description |
|------|--|
| (1) | Model name and firmware version |
| (2) | Message |
| (3) | The number of labels printed |
| (4) | IP address (only when LAN/WLAN is enabled.) |
| (5) | Radio intensity (only when WLAN is enabled.) Indicates the radio intensity in 4 levels. |
| (6) | WLAN connection (only when WLAN is enabled.) <ul style="list-style-type: none"> ▪ Lights up when connecting to an access point. ▪ Flashes while roaming. ▪ Goes off when disconnected. |
| (7) | Presence of a print job Appears when a print job exists. |
| (8) | RFID (only when RFID module is installed.) <ul style="list-style-type: none"> ▪ Appears when a communication between the printer and the RFID module is enabled. ▪ Flashes while communicating with the RFID module. |
| (9) | Ribbon near end Flashes when a ribbon near end state is detected. |
| (10) | The number of remaining labels to print |
| (11) | Error description and solution |
| (12) | Help guide Appears when a help guide message is provided. Press the [RIGHT] key to see the help guide message. |

3.3 Operation Example

■ Online Mode

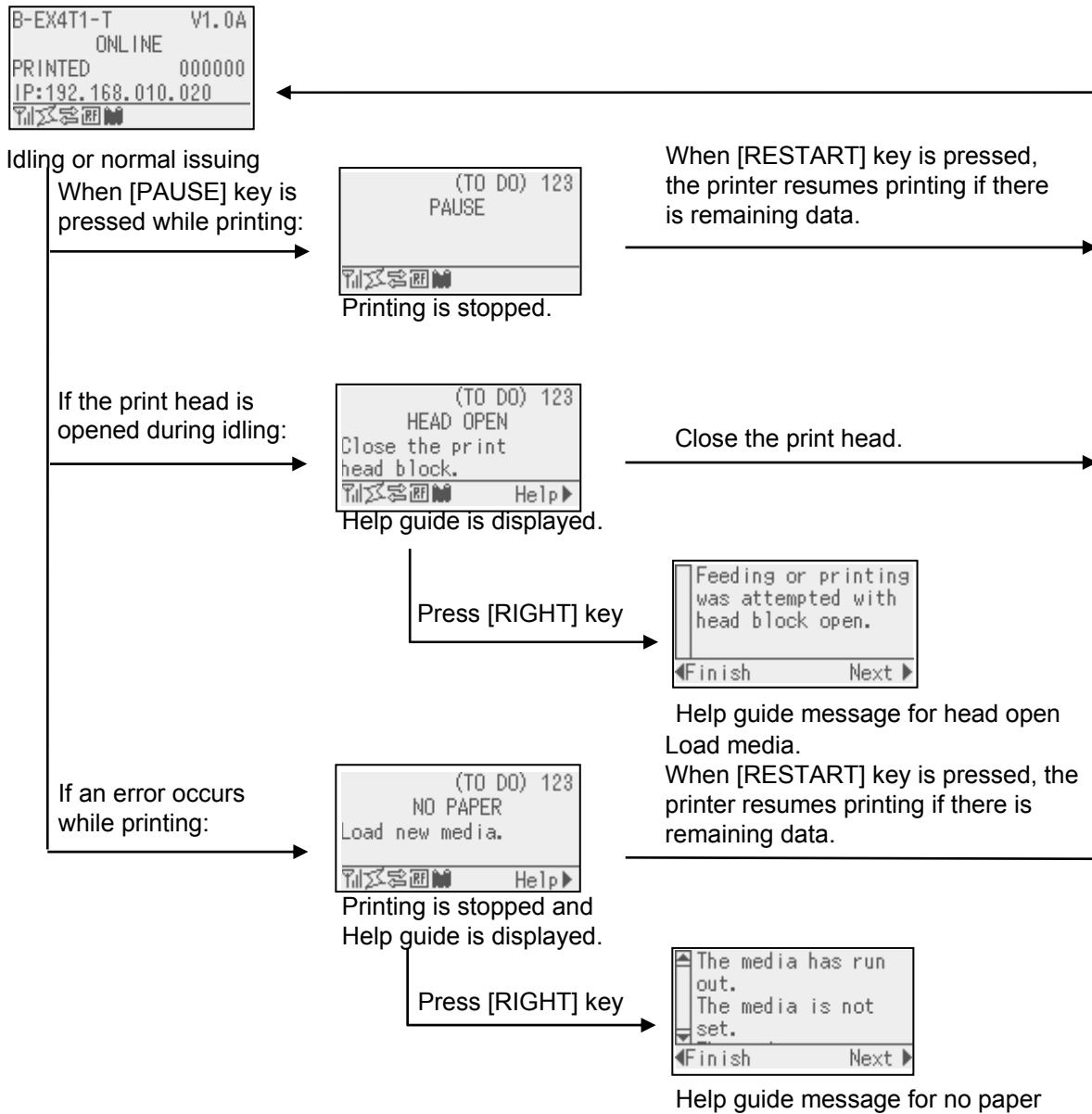

3.3 Operation Example (Cont.)

■ Help Guide Message

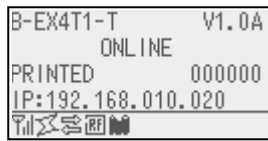

Idling or normal issuing

If an error occurs while printing:



Printing is stopped and Help guide is displayed.

Load media.
When [RESTART] key is pressed, the printer resumes printing if there is remaining data.

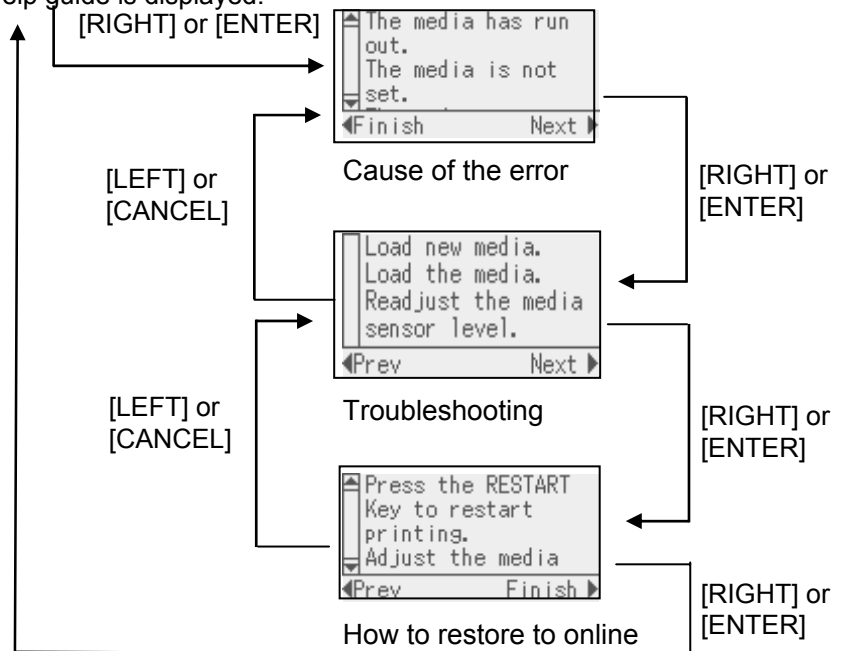

3.3 Operation Example (Cont.)

■ Cancellation of Print Job

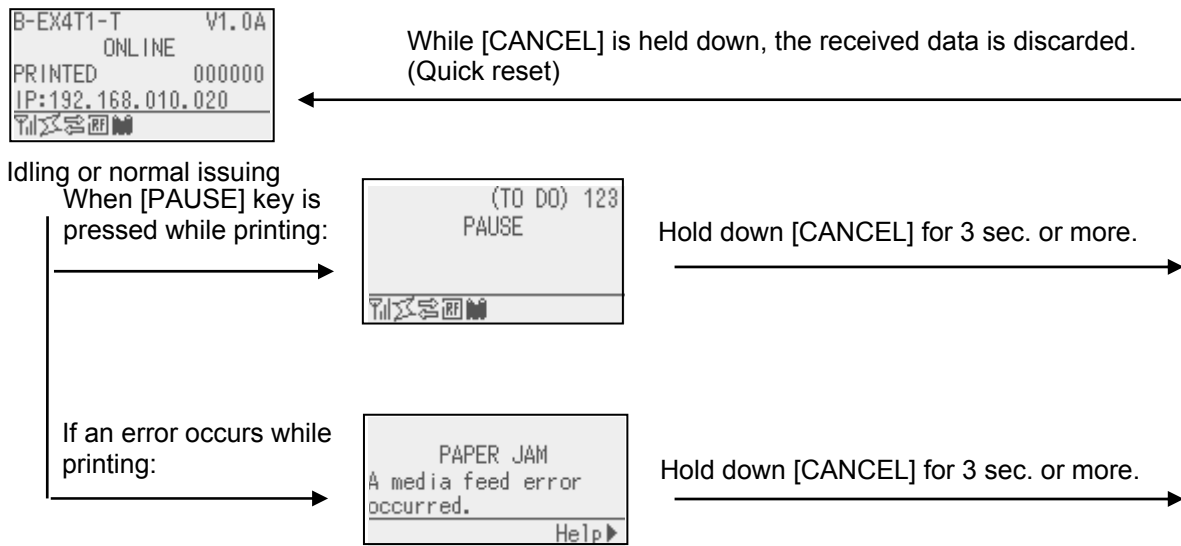

3.4 Power Save Function

3.4.1 Entering the Power Saving Mode

When the printer stays in any of the following statuses for the specified length of time, it enters the power saving mode.

- Online (Idle, communicating)
- Pause
- Error
- Waiting for label to be removed
- System mode (except for self-diagnosis, test print, sensor adjustment)
- User system mode (except for dump)
- Pause state of the expansion I/O

When the printer enters the power saving mode, "POWER SAVING MODE" is displayed on the LCD and the backlight goes off.

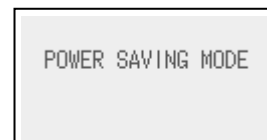

When the following occurs in the power saving mode, the LCD wakes up.

- A key is pressed. (Except for [RESTART] or [FEED] key which causes printing or paper feed.)
- The head lever is released and locked.
- The status of the pause or active signal of the expansion I/O changes.

The LCD shows "POWER SAVING MODE" and the backlight goes off again if no status change occurs on the printer for 30 seconds.

3.4.2 Exiting the Power Saving Mode

The printer exits the power saving mode when:

- printing (printing caused by a depression of the [RESTART] key is included.) is performed.
- paper feed or re-prints caused by a depression of the [FEED] key
- printing or paper feed is initiated through the expansion I/O
- automatic calibration is performed
- sensor adjustment is performed in the system mode
- the printer receives commands (U1/U2, T, XS, IB, or RFID-related commands).

4. MAINTENANCE

WARNING!

1. Be sure to disconnect the power cord before performing maintenance. Failure to do this may cause an electric shock.
2. To avoid injury, be careful not to pinch your fingers while opening or closing the cover and print head block.
3. The print head becomes hot immediately after printing. Allow it to cool before performing any maintenance.
4. Do not pour water directly onto the printer.

This chapter describes how to perform routine maintenance.

To ensure the continuous high quality operation of the printer, you should perform a regular maintenance routine. For high usage it should be done on a daily basis. For low usage it should be done on a weekly basis.

4.1 Cleaning

To maintain the printer performance and print quality, please clean the printer regularly, or whenever the media or ribbon is replaced.

4.1.1 Print Head/Platen/Sensors

CAUTION!

1. Do not use any volatile solvent including thinner and benzene, as this may cause discoloration to the cover, print failure, or breakdown of the printer.
2. Do not touch the Print Head Element with bare hands, as static may damage the Print Head.

1. Turn off the power and unplug the printer.
2. Open the Top Cover.
3. Turn the Head Lever to the "FREE" position, and then release the Ribbon Shaft Holder Plate.
4. Open the Print Head Block.
5. Remove the ribbon and media.

CAUTION!

When cleaning the print head, be careful not to damage the print head with hard objects like watches or rings.

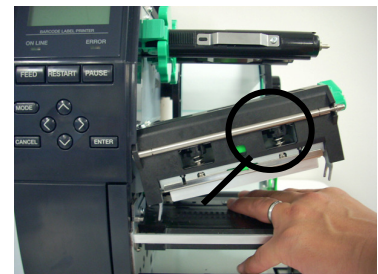

Care must be taken not to allow the metal or glass part of a watch to touch the print head edge.

Care must be taken not to allow a metal object like a ring to touch the print head edge.

Since the print head element can be easily damaged by shock, please treat it carefully and do not hit it with hard objects.

6. Clean the Print Head Element with a Print Head Cleaner or a cotton swab or soft cloth slightly moistened with alcohol.

4.1.1 Print Head/Platen/Sensors (Cont.)

NOTE:

Please purchase the Print Head Cleaner from your authorised TOSHIBA TEC service representative.

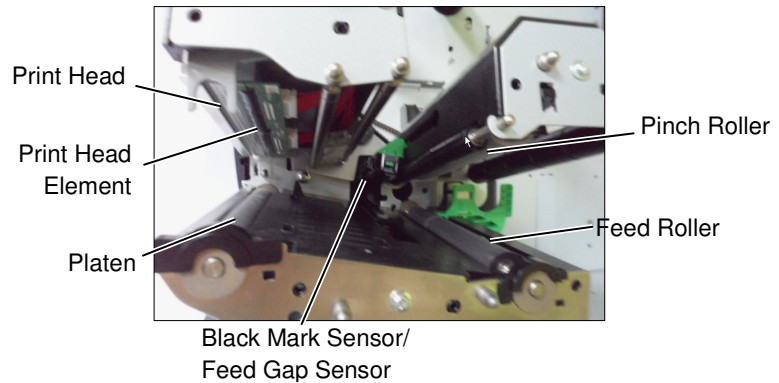

7. Wipe the Platen, Feed Roller, and Pinch Roller with a soft cloth slightly moistened with alcohol. Remove dust or foreign substances from the internal parts of the printer.
8. Wipe the Feed Gap Sensor and Black Mark Sensor with a dry soft cloth.

Wipe the covers and panels with a dry soft cloth or a cloth slightly moistened with a mild detergent solution.

4.1.2 Covers and Panels

CAUTION!

1. DO NOT POUR WATER directly onto the printer.
2. DO NOT APPLY cleaner or detergent directly onto any cover or panel.
3. NEVER USE THINNER OR OTHER VOLATILE SOLVENT on the plastic covers.
4. DO NOT clean the panel, covers, or the supply window with alcohol as it may cause them to discolour, lose their shape or develop structural weakness.



4.1.3 Optional Cutter Module

WARNING!

1. *Be sure to turn the power off before cleaning the Cutter Module.*
2. *As the cutter blade is sharp, care should be taken not to injure yourself while cleaning.*

The disc cutter and rotary cutter are available as an option. They are both cleaned in the same way. When removing the Cutter Cover of the rotary cutter unit, remove the screws from the bottom of the cover.

1. Loosen the two Plastic Head Screws to remove the Cutter Cover.
2. Remove the jammed paper.
3. Clean the Cutter with a soft cloth slightly moistened with alcohol.
4. Attach the Cutter Cover.

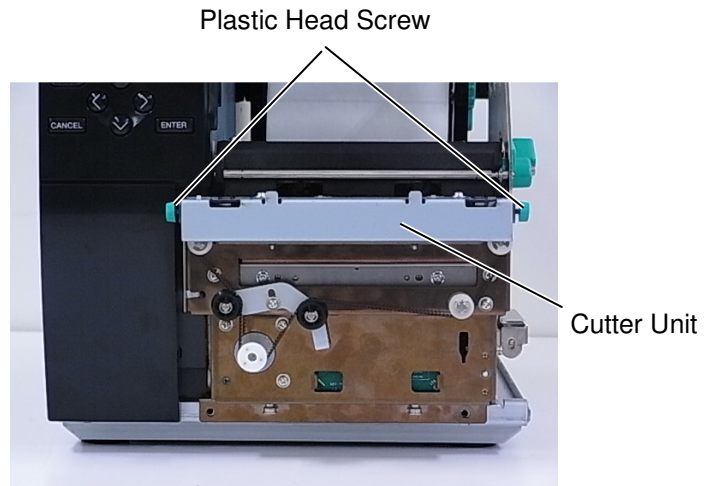

5. TROUBLESHOOTING

This chapter lists the error messages, possible problems, and their solutions.

WARNING!

If a problem cannot be solved by taking the actions described in this chapter, do not attempt to repair the printer. Turn off and unplug the printer, then contact an authorised TOSHIBA TEC service representative for assistance.

5.1 Error Messages

NOTES:

- If an error is not cleared by pressing the **[RESTART]** key, turn the printer off and then on.
- After the printer is turned off, all print data in the printer is cleared.

| Error Messages | Problems/Causes | Solutions |
|--------------------|---|---|
| HEAD OPEN | The Print Head Block is opened in Online mode. | Close the Print Head Block. |
| | Feeding or printing has been attempted with the Print Head Block open. | Close the Print Head Block. Then press the [RESTART] key. |
| COMMS ERROR | A communication error has occurred. | Make sure the interface cable is correctly connected to the printer and the host and the host is turned on. |
| PAPER JAM | 1. The media is jammed in the media path. The media is not fed smoothly. | 1. Remove the jammed media, and clean the Platen. Reload the media correctly. Press the [RESTART] key. ⇒ Section 5.3. |
| | 2. The media is not loaded properly. | 2. Reload the media correctly. Then press the [RESTART] key. ⇒ Section 2.3. |
| | 3. Wrong Media Sensor is selected for the media being used. | 3. Turn the printer off and then on. Select the Media Sensor for the media type being used. Resend the print job. |
| | 4. The Black Mark Sensor is not correctly aligned with the Black Mark on the media. | 4. Adjust the sensor position, then press the [RESTART] key. ⇒ Section 2.3.1. |
| | 5. Size of the loaded media is different from the programmed size. | 5. Replace the loaded media with one that matches the programmed size, press the [RESTART] key, or turn the printer off and then on, select a programmed size that matches the loaded media. Resend the print job. |
| | 6. Media sensor has not been properly calibrated for the media being used. | 6. Refer to Section 2.10 to set the threshold. If this does not solve the problem, turn off the printer, and call a TOSHIBA TEC authorised service representative. |

5.1 Error Messages (Cont.)

| Error Messages | Problems/Cause | Solutions |
|---|--|--|
| CUTTER ERROR (Only when the cutter module is installed on the printer.) | 1. The media is jammed in the cutter. | 1. Remove the jammed media. Press the [RESTART] key. If this does not solve the problem, turn off the printer, and call a TOSHIBA TEC authorised service representative. ⇒ Section 4.1.3. |
| | 2. The Cutter Cover is not attached properly. | 2. Attach the Cutter Cover properly. |
| NO PAPER | 1. The media has run out. | 1. Load new media. Press the [RESTART] key. ⇒ Section 2.3.1. |
| | 2. The media is not loaded properly. | 2. Reload the media correctly. Press the [RESTART] key. ⇒ Section 2.3.1. |
| | 3. The media sensor position has not been adjusted properly. | 3. Adjust the sensor position. Press the [RESTART] key. ⇒ Section 2.3.1. |
| | 4. Media sensor has not been properly calibrated for the media being used. | 4. Refer to Section 2.10 to set the threshold. If this does not solve the problem, turn off the printer, and call a TOSHIBA TEC authorised service representative. |
| | 5. The media is slack. | 5. Take up any slack in the media. |
| RIBBON ERROR | 1. The ribbon is not fed properly. | 1. Remove the ribbon and check the status of the ribbon. Replace the ribbon if necessary. If the problem is not solved, turn off the printer, and call a TOSHIBA TEC authorised service representative. |
| | 2. The ribbon is not loaded. | 2. Load a ribbon. ⇒ Section 2.3.2 |
| | 3. The ribbon sensor has a problem. | 3. Turn off the printer and call a TOSHIBA TEC authorised service representative. |
| NO RIBBON | The ribbon has run out. | Load a new ribbon. Press the [RESTART] key. ⇒ Section 2.3.2. |
| REWIND FULL | The Built-in Rewinder Unit is full. | Remove the backing paper from the Built-In Rewinder Unit. Press the [RESTART] key. |
| EXCESS HEAD TEMP | The Print Head has overheated. | Turn off the printer and allow it to cool down for about 3 minutes. If this does not solve the problem call a TOSHIBA TEC authorised service representative. |
| HEAD ERROR | There is a problem with the Print Head. | Replace the Print Head. |
| POWER FAILURE | A momentary power failure has occurred. | Check that the power source, which supplies power to the printer, is the correct rating. If the printer shares the same power outlet with other electrical appliances that consume large amounts of power, use a different outlet. |

5.1 Error Messages (Cont.)

| Error Messages | Problems/Cause | Solutions |
|--|---|---|
| SYSTEM ERROR | 1. The printer is used in a location where it is subject to noise or there are power cords from other electrical appliances near the printer or interface cables. | 1. Keep the printer and the interface cables away from the source of noise |
| | 2. The Power Cord of the printer is not grounded. | 2. Ground the Power Cord. |
| | 3. The printer shares the same power source with any other electrical appliances. | 3. Provide an exclusive power source for the printer. |
| | 4. An application software used on your host computer has an error or malfunction. | 4. Confirm the host computer operates properly. |
| MEMORY WRITE ERR. | An error has occurred in writing to the flash ROM/USB memory. | Turn the printer off, and then on again. |
| FORMAT ERROR | An error has occurred in formatting the flash ROM/USB memory. | Turn the printer off, and then on again. |
| MEMORY FULL | Saving failed because of insufficient storage space in the flash ROM/USB memory. | Turn the printer off, and then on again. |
| EEPROM ERROR | Data cannot be read-from or written-to a backup EEPROM properly. | Turn the printer off, and then on again. |
| RFID WRITE ERROR | The printer did not succeed in writing data onto an RFID tag after retrying the specified number of times. | Press the [RESTART] key. |
| RFID ERROR | The printer cannot communicate with the RFID module. | Turn the printer off, and then on again. |
| LOW BATTERY | The voltage of the Real Time Clock Battery is low. | If you wish to keep using the same battery even after "LOW BATTERY" error occurs, turn off the printer and start it in the system mode, set the date and time for the RTC and reset the printer. As long as the power is on the date and time will be correct. Call a TOSHIBA TEC authorised service representative to replace the battery. |
| SYNTAX ERROR | While the printer is in the Download mode for upgrading the firmware, it receives an improper command, for example, an Issue Command. | Turn the printer off, and then on again. |
| PASSWORD INVALID Please Power OFF | A wrong password was entered three consecutive times. | Please consult the system administrator. |
| Other error messages | A hardware or software problem may have occurred. | Turn the printer off and then on. If this does not solve the problem, turn off the printer, and call a TOSHIBA TEC authorised service representative. |

5.2 Possible Problems

This section describes problems that may occur when using the printer, and their causes and solutions.

| Possible Problems | Causes | Solutions |
|--|---|---|
| The printer will not turn on. | 1. The Power Cord is disconnected. | 1. Plug in the Power Cord. |
| | 2. The AC outlet is not functioning correctly. | 2. Test with a power cord from another electrical appliance. |
| | 3. The fuse has blown, or the circuit breaker has tripped. | 3. Check the fuse or circuit breaker. |
| The media will not feed. | 1. The media is not loaded properly. | 1. Load the media properly. ⇒ Section 2.3.1. |
| | 2. The printer is in an error condition. | 2. Solve the error in the message display. (See Section 5.1 for more detail.) |
| Pressing the [FEED] key in the initial state results in an error. | A feed was attempted contrary to the following default conditions. Sensor type: Feed gap sensor Printing method: Thermal transfer Media pitch: 76.2 mm | Change the print condition by using the printer driver or a print command so that it corresponds to your printing conditions. Clear the error state by pressing the [RESTART] key. |
| Nothing is printed on the media. | 1. The media is not loaded properly. | 1. Load the media properly. ⇒ Section 2.3.1. |
| | 2. The ribbon is not loaded properly. | 2. Load the ribbon properly. ⇒ Section 2.3.2. |
| | 3. The print head is not installed properly. | 3. Install the print head properly and close the Print Head Block. |
| | 4. The combination of the ribbon and media is not correct. | 4. Select an appropriate ribbon for the media type being used. |
| The printed image is blurred. | 1. The combination of the ribbon and media is not correct. | 1. Select an appropriate ribbon for the media type being used. |
| | 2. The Print Head is not clean. | 2. Clean the print head using the Print Head Cleaner or a cotton swab slightly moistened with ethyl alcohol. |
| The cutter does not cut. | 1. The Cutter Cover is not attached properly. | 1. Attach the Cutter Cover properly. |
| | 2. The media is jammed in the Cutter. | 2. Remove the jammed paper. ⇒ Section 4.1.3. |
| | 3. The cutter blade is dirty. | 3. Clean the cutter blade. ⇒ Section 4.1.3. |
| The Strip Module does not remove labels from the backing paper. | Label stock is too thin or the glue is too sticky. | 1. Refer to Section 7.1 Media and change the label. |
| | | 2. Set the Pre Peel function to ON. ⇒ Section 2.6.2. |

5.3 Removing Jammed Media

This section describes, in detail, how to remove jammed media from the printer.

CAUTION!
Do not use any tool that may damage the Print Head.

1. Turn off and unplug the printer.
2. Open the Top Cover.
3. Turn the Head Lever to **FREE** position, then open the Ribbon Shaft Holder Plate.
4. Open the Print Head Block.
5. Remove the ribbon and media.

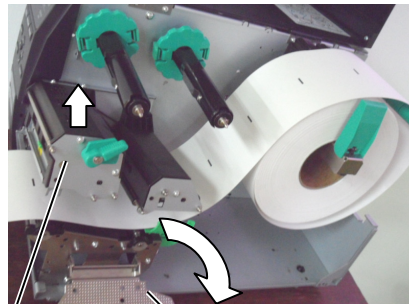

Print Head Block

Ribbon Shaft Holder Plate

6. Remove the jammed media from the printer. DO NOT use any sharp implements or tools as these could damage the printer.
7. Clean the Print Head and Platen, then remove any further dust or foreign substances.
8. Paper jams in the Cutter Unit can be caused by wear or residual glue from label stock on the cutter. Do not use non-specified media in the cutter.

NOTE:
If you get frequent jams in the cutter, contact a TOSHIBA TEC authorised service representative.

CAUTION!

When removing the jammed media, be careful not to damage the print head with hard objects like watches or rings.

Care must be taken not to allow the metal or glass part of a watch to touch the print head.

Care must be taken not to allow a metal object like a ring to touch the print head.

Since the print head element can be easily damaged by shock, please treat it carefully and do not hit it with hard objects.

6. PRINTER SPECIFICATIONS

This section describes the printer specifications.

| Item | | Model | B-EX4T2-GS12-QM-R/CN-R | B-EX4T2-TS12-QM-R/CN-R | B-EX4T2-HS12-QM-R/CN-R |
|---|---------------------|--|--|---|---|
| Dimension (W x D x H) | | 278 mm x 460 mm x 310 mm (10.9" x 18.1" x 12.2") | | | |
| Weight (kg) | | 17 kg | | | |
| Operating temperature range | | 5 degC to 40 degC (40 degF to 104 degF) | | | |
| Relative humidity | | 25% to 85% RH (no condensation) | | | |
| Power supply | | Universal switching power source AC 100 V to 240 V, 50/60 Hz +/- 10% | | | |
| Input voltage | | AC100 V to 240 V, 50/60 Hz +/- 10% | | | |
| Power Consumption | During a print job* | 157.34W 0.71A | | | |
| | During stand-by | 15W or less | | | |
| | During sleep mode | 5.7W 0.09A | | | |
| Resolution | | 8 dots/mm (203 dpi) | 11.8 dots/mm (300 dpi) | 23.6 dots/mm (600 dpi) | |
| Printing method | | Thermal transfer or Thermal direct | | | |
| Printing speed | | 76.2mm/sec. (3 in/sec.) 152.4mm/sec. (6 in/sec.) 254.0mm/sec.(10 in/sec.) 304.8mm/sec.(12 in/sec.) | 76.2 mm/sec. (3 in/sec.) 127.0mm/sec. (5 in/sec.) 203.8mm/sec. (8 in/sec.) 254.0mm/sec.(10 in/sec.) 304.8mm/sec.(12 in/sec.) | 50.8 mm/sec. (2 in/sec.) 76.2 mm/sec. (3 in/sec.) 101.6 mm/sec. (4 in/sec.) 127.0mm/sec. (5 in/sec.) 152.4mm/sec. (6 in/sec.) | |
| Available media width (including backing paper) | | 25.0 mm to 114.0 mm (0.98 inches to 4.49 inches) | | | 15.0 mm to 114.0 mm (0.59inches to 4.49 inches) |
| Effective print width (max.) | | 104.0 mm (4.1 inches) | | | |
| Issue mode | | Batch Strip (Strip mode is enabled only when the optional Strip Module is installed.) Cut (Cut mode is enabled only when the optional Cutter Module is installed.) | | | |
| LCD Message display | | Graphic type 128 x 64 dots | | | |

*: While 20% slant lines are printed in the specified format.

| Model | B-EX4T2-GS12-QM-R/CN-R | B-EX4T2-TS12-QM-R/CN-R | B-EX4T2-HS12-QM-R/CN-R |
|----------------------|--|------------------------|------------------------|
| Item | | | |
| Bar code types | JAN8, JAN13, EAN8, EAN8+2 digits, EAN8+5 digits, EAN13, EAN13+2 digits, EAN13+5 digits, UPC-E, UPC-E+2 digits, UPC-E+5 digits, UPC-A, UPC-A+2 digits, UPC-A+5 digits, MSI, ITF, NW-7, CODE39, CODE93, CODE128, EAN128, Industrial 2 to 5, Customer Bar Code, POSTNET, KIX CODE, RM4SCC (ROYAL MAIL 4 STATE CUSTOMER CODE), GS1 DataBar | | |
| Two-dimensional code | Data Matrix, PDF417, QR code, Maxi Code, Micro PDF417, CP Code | | |
| Font | Times Roman (6 sizes), Helvetica (6 sizes), Presentation (1 size), Letter Gothic (1 size), Prestige Elite (2 sizes), Courier (2 sizes), OCR (2 types), Gothic (1 size), Outline font (4 types), Price font (3 types) 24 x 24 Simp-Chinese font (only CN model) | | |
| Rotations | 0, 90, 180, 270 deg | | |
| Standard interface | USB interface LAN interface | | |
| Optional interface | Serial interface (B-EX700-RS-QM-R) Parallel interface (B-EX700-CEN-QM-R) Expansion I/O interface (B-EX700-IO-QM-R) RTC & USB Host interface (B-EX700-RTC-QM-R) Wireless LAN interface (B-EX700-WLAN-QM-R) Note: B-EX4T2-GS12/TS12/HS12-CN-R does not support WLAN option I/F. (For China area, a user should purchase B-EX4T2-GS16/TS16/HS16-CN-R when use WLAN I/F.) | | |
| Optional Module | Disc cutter module (B-EX204-QM-R) Strip module (B-EX904-H-QM-R) RFID module mount kit (B-EX700-RFID-H1-QM-R) | | |
| Optional Kit | 203-dpi print head (B-EX704-TPH2-QM-R) 300-dpi print head (B-EX704-TPH3-QM-R) 600-dpi print head (B-EX704-TPH6-QM-R) Note: 600-dpi print head is only with B-EX4T2-HS12 Model. | | |

NOTES:

- *Data Matrix™* is a trademark of International Data Matrix Inc., U.S.
- *PDF417™* is a trademark of Symbol Technologies Inc., US.
- *QR Code* is a trademark of DENSO CORPORATION.
- *Maxi Code* is a trademark of United Parcel Service of America, Inc., U.S.

7. SUPPLY SPECIFICATIONS

7.1 Media

Please make sure that the media being used is approved by TOSHIBA TEC. The warranty does not apply when a problem is caused by using media that is not approved by TOSHIBA TEC. For information regarding TOSHIBA TEC approved media, please contact a TOSHIBA TEC authorised service representative.

7.1.1 Media Type

Two types of media can be loaded for this thermal transfer and direct thermal printer: label or tag. The table below shows size and shape of the media available for this printer.

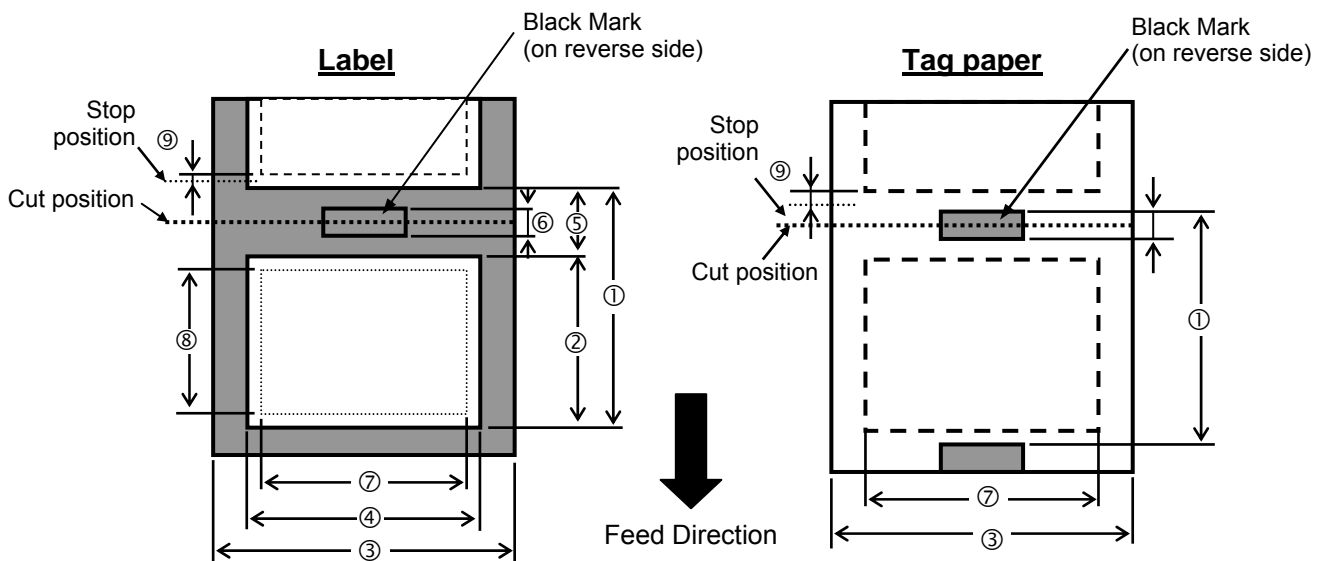

Paper Size and Shape

| Item | | B-EX4T2 | | | | | | | | | | |
|----------------------|-----------------------------------|-------------------|-----------------|----------------|----------------------|-----------------|----------------|----------------------|--------|----------------|----------------|-------|
| Thermal head density | | 8dots/mm (203dpi) | | | 11.8dots/mm (300dpi) | | | 23.6dots/mm (600dpi) | | | | |
| Thermal head width | | 104.0mm | | | 108.416mm | | | 105.58mm | | | | |
| Contents | Issue type | Batch | Strip *Note1 | Disc Cutter | Batch | Strip *Note1 | Disc Cutter | Batch | Strip | Disc Cutter | | |
| 1. | Paper Pitch | Label | Min. | 10.0 | 15.0 | 25.0 | 10.0 | 15.0 | 25.0 | 7.0 | 12.0 | 25.0 |
| | | | Max. | 1500.0 | 1500.0 | 1500.0 | 1500.0 | 1500.0 | 1500.0 | 500.0 | 500.0 | 500.0 |
| | Tag | Min. | 10.0 | — | 25.0 | 10.0 | — | 25.0 | 10.0 | — | 25.0 | |
| | | Max. | 1500.0 | — | 1500.0 | 1500.0 | — | 1500.0 | 500.0 | — | 500.0 | |
| 2. | Paper length | Min. | 8.0 | 17.0 | 19.0 *Note2 | 8.0 | 17.0 | 19.0 *Note2 | 5.0 | 10.0 | 19.0 *Note2 | |
| | | Max. | 1498.0 | 1498.0 | 1494.0 | 1498.0 | 1498.0 | 1494.0 | 498.0 | 498.0 | 494.0 | |
| 3. | Tag width and Backing paper width | Min. | 25.0 | 25.0 | 25.0 | 25.0 | 25.0 | 25.0 | 15.0 | 15.0 | 15.0 | |
| | | Max. | Direct | 114.0 | | | 114.0 | | | 114.0 | | |
| | | | Transfer | 108.0 | | | 108.0 | | | 108.0 | | |
| 4. | Label width | Min. | 22.0 | | | 22.0 | | | 22.0 | | | |
| | | Max. | Direct | 111.0 | | | 111.0 | | | 111.0 | | |
| | | | Transfer | 105.0 | | | 105.0 | | | 105.0 | | |
| 5. | Label-to-label gap | Min. | 2.0 | 6.0 | 2.0 | 6.0 | 2.0 | 6.0 | 2.0 | 6.0 | | |
| | | Max. | 20.0 | | | 20.0 | | | 20.0 | | | |
| 6. | Black mark length | Min. | 2.0 | | | 2.0 | | | 2.0 | | | |
| | | Max. | 10.0 | | | 10.0 | | | 10.0 | | | |

| | | | | | | | | | | | | |
|-----|---------------------------------------|--|------------|--------|--|------------|--------|--|------------|-------|-------|-------|
| 7. | Max. effective print width | Max. | 104.0 +0.2 | | | 104.0 +0.2 | | | 104.0 +0.2 | | | |
| 8. | Effective print length | Label | Min. | 6.0 | 15.0 | 17.0 | 6.0 | 15.0 | 17.0 | 3.0 | 8.0 | 17.0 |
| | | | Max. | 1496.0 | 1496.0 | 1492.0 | 1496.0 | 1496.0 | 1492.0 | 496.0 | 496.0 | 492.0 |
| | | Tag | Min. | 8.0 | — | 19.0 | 8.0 | — | 21.4 | 5.0 | — | 19.0 |
| | | | Max. | 1498.0 | — | 1498.0 | 1498.0 | — | 1498.0 | 498.0 | — | 498.0 |
| 9. | Slow-up and down area (Un-print area) | Slow-up | 1.0 | | | 1.0 | | | 1.0 | | | |
| | | Slow-down | 1.0 | | | 1.0 | | | 1.0 | | | |
| 10. | Paper thickness | Min. | 0.13 | | | 0.13 | | | 0.13 | | | |
| | | Max. | 0.17 | | | 0.17 | | | 0.17 | | | |
| 11. | Paper thickness can be cut | Min. | - | 0.08 | - | 0.08 | - | 0.08 | - | 0.08 | | |
| | | Max. | - | 0.17 | - | 0.17 | - | 0.17 | - | 0.17 | | |
| 12. | Max. paper roll diameter | φ200 (Using external rewriter φ180) | | | φ200 (Using external rewriter φ180) | | | φ200 (Using external rewriter φ180) | | | | |
| 13. | Paper winding direction | Inside the printing side (STD.) | | | Inside the printing side (STD.) | | | Inside the printing side (STD.) | | | | |
| 14. | Paper core | Inside diameter φ76.2±0.3 | | | Inside diameter φ76.2±0.3 | | | Inside diameter φ76.2±0.3 | | | | |

NOTES:

1. To ensure print quality and print head life use only TOSHIBA TEC specified media.
2. When using the peel-off at 12"/sec or more for 203dpi model, issue at 10"/sec.
When using the peel-off at 10"/sec or more for 300dpi model, issue at 8"/sec.
3. When using the disk cutter, the label length must meet the following condition:
Label length 18.0mm - (Gap length/2).
4. The Strip Module do not support the print speed of 10"/sec. or faster.
5. The ratio of a label length to a gap length must be a minimum of 3 to 1 (3:1).
6. When using label stock in cut mode, be sure to cut in the gaps. Cutting labels will cause the adhesive to stick to the cutter, which may affect the cutter performance and shorten the cutter life.
7. When the Strip Module is used on the GS12 (203 dpi) model, the print speed is automatically corrected to 10"/sec. if 12"/sec. or faster is specified.
When the Strip Module is used on the TS12 (300 dpi) model, the print speed is automatically corrected to 8"/sec. if 8"/sec. or faster is specified.

7.1.2 Detection Area of the Transmissive Sensor

Sensor position

The sensor is movable in the range from the center of the paper to the left end. Transmissive sensor and Reflective sensor are moving from side to side at same time each sensor unit.

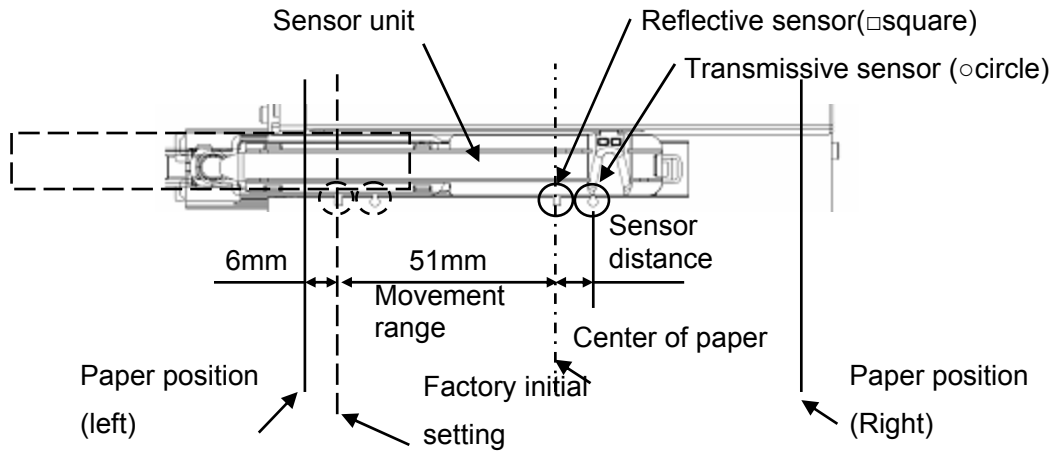

Detection Area of Transmissive Sensor

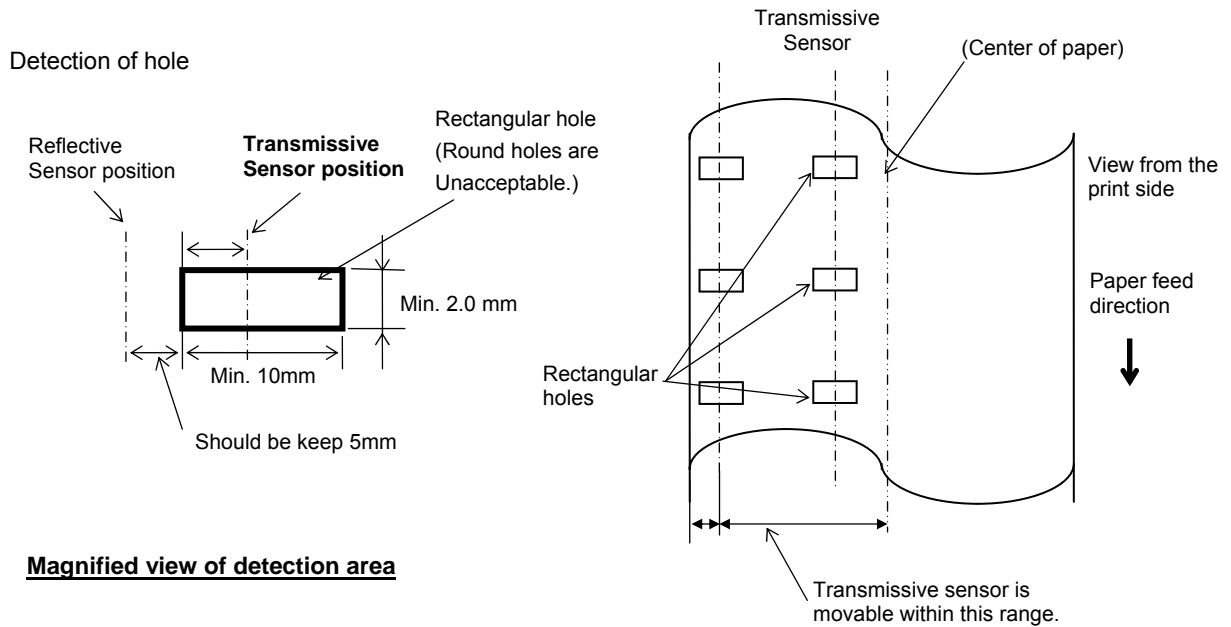

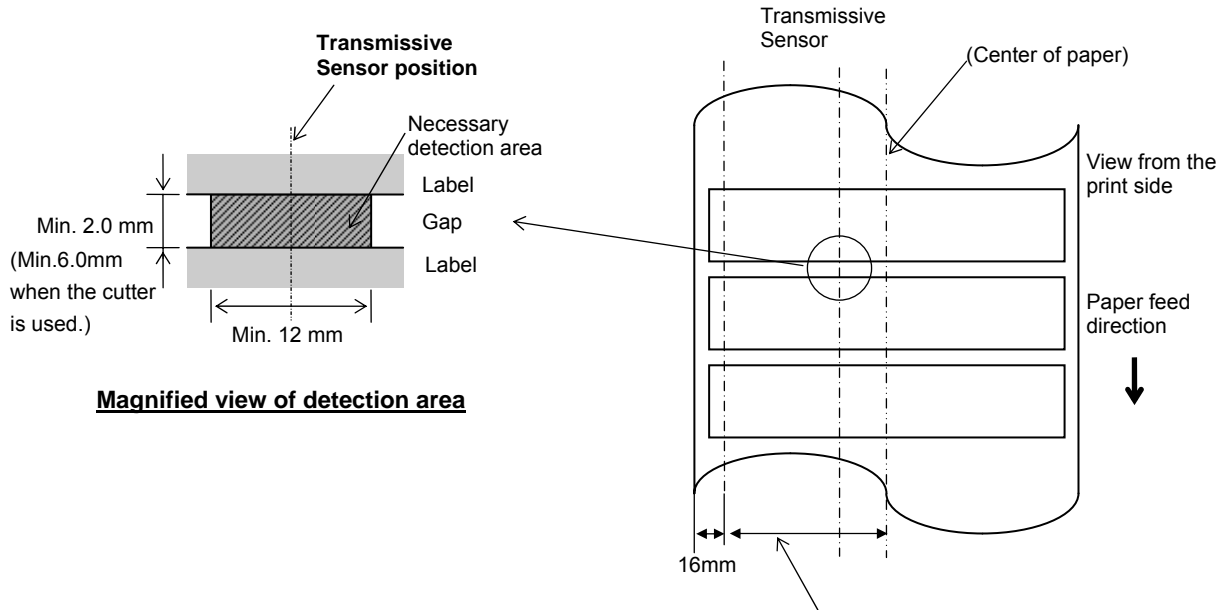

7.1.3 Detection Area of the Reflective Sensor

The Reflective Sensor is movable from the centre to the left edge of media.
 The reflection factor of the Black Mark must be 10% or lower with a waveform length of 950 nm.
 The Reflective Sensor should be aligned with the centre of the Black Mark.
 The black marks, if necessary, must be printed on the labels in the gap areas.
 Rectangular holes can substitute the black marks, on the condition that nothing is printed on the back side.

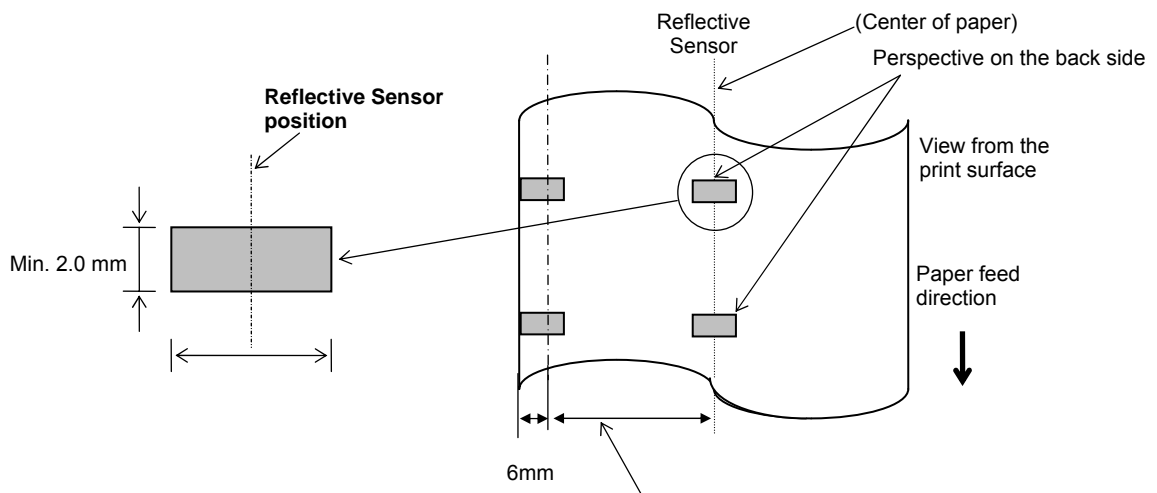

7.1.4 Effective Print Area

7.1.4.1 Relationship between Print Head Effective Print Width and Paper Width

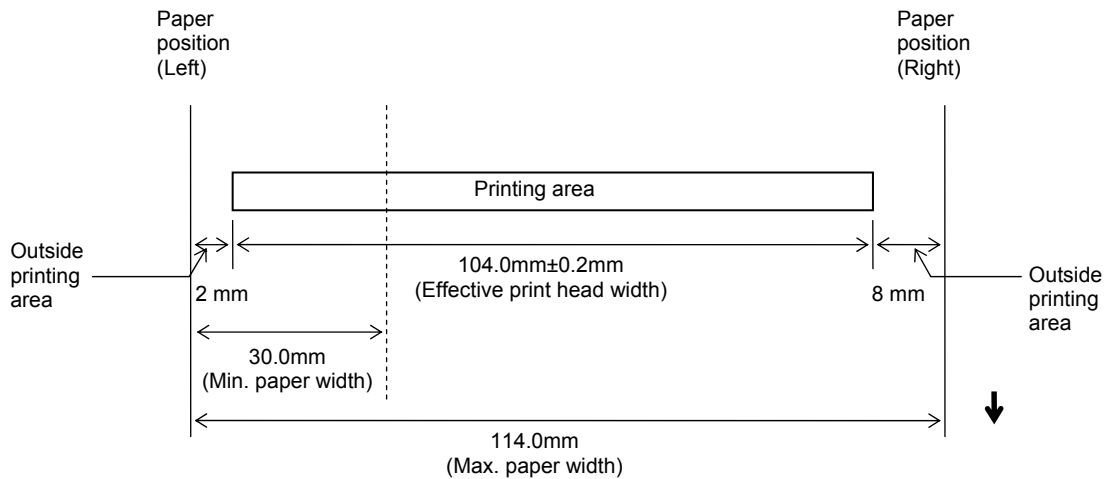

7.1.4.2 Effective Print Area of Tags and Labels

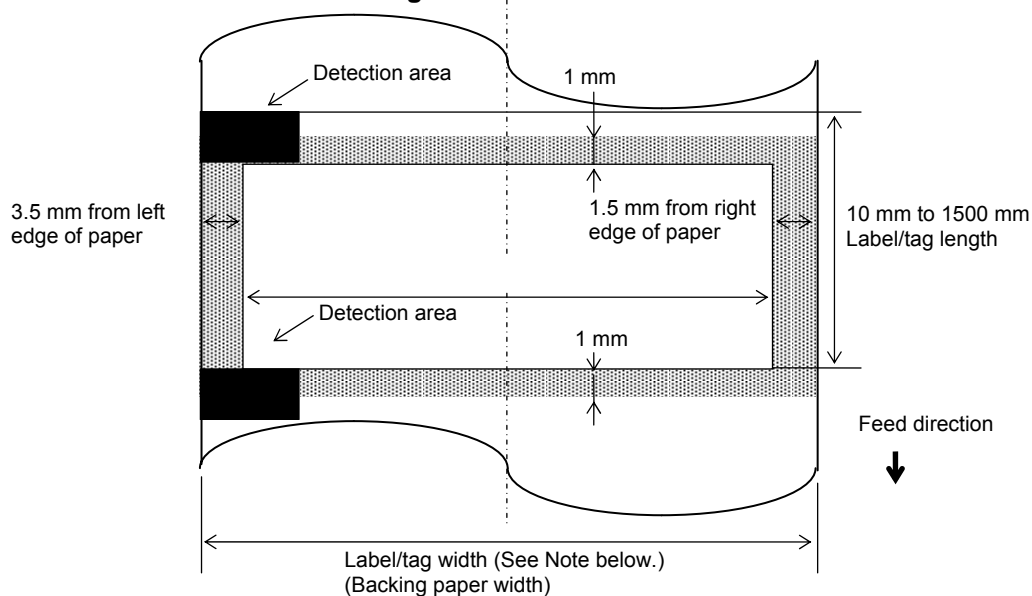

NOTES:

1. *Print quality in the shaded area is not guaranteed. For the label, printing in the 1-mm width area around the label is not guaranteed as well as the shaded area shown above.*
2. *This printer paper set position is left side, The center of the paper (label and tag) is not almost aligned with the center of the print head.*
3. *If printing is performed in the shaded area, the ribbon may wrinkle. This may affect the print quality of the guaranteed printing area.*

7.1.5 RFID Tags

Available RFID tag types are different depending on the RFID modules/printers, as follows:

■ B-EX700-RFID-H1-QM-R

- TAGSYS C210
- TAGSYS C220
- TAGSYS C240
- TAGSYS C320 (Only when the TAGSYS S003 module is used.)
- I-Code
- Tag-it
- ISO15693

Cautions for using RFID Tags

(1) Lift-up of Print Head

An RFID tag chip or the print head may be damaged when the print head passes over the chip.

(2) Storage of RFID Supplies

Do not store RFID tags close to printers, as their read/write performance may be compromised when they are used.

(3) Roll-type RFID Supplies

When RFID supplies are to be rolled, roll hardness must be considered.

Although it depends on the type of adhesive, tag, and backing paper, RFID-tag embedded labels tend to stay rolled. Especially, when they are outside wound, a paper jam error may occur. Unless otherwise specified, it is recommended that the RFID-tag embedded labels be inside wound.

(4) Sensor

When the transmissive sensor or reflective sensor is enabled, transmittance or reflectivity of a label or tag may vary at an RFID-tag embedded area depending on the pattern of the antenna or other factors. In such cases, a manual threshold setting is required. For details, refer to **Section 2.10 Threshold Setting**.

(5) Cutter

When an RFID label or tag is used in cut issue mode, care must be taken not to cut the antenna of the RFID tag or the IC chip so as not to damage the cutter.

(6) Static Electricity

When printing is performed in a place where humidity is low or under some specific conditions, writing data on an RFID tag may fail due to static electricity generated by the label or ribbon.

(7) Printing on Bump (Chip/Antenna) Area

Embedding an RFID tag in labels creates bumps on the label surface, causing incomplete printing. Uneven printing or incomplete printing can occur easily, especially within 5 mm top and bottom, and to the left and right sides of the RFID-tag embedded area, as shown in the figure below.

NOTE: *The degree of poor printing quality differs depending on height of a chip/antenna used.*

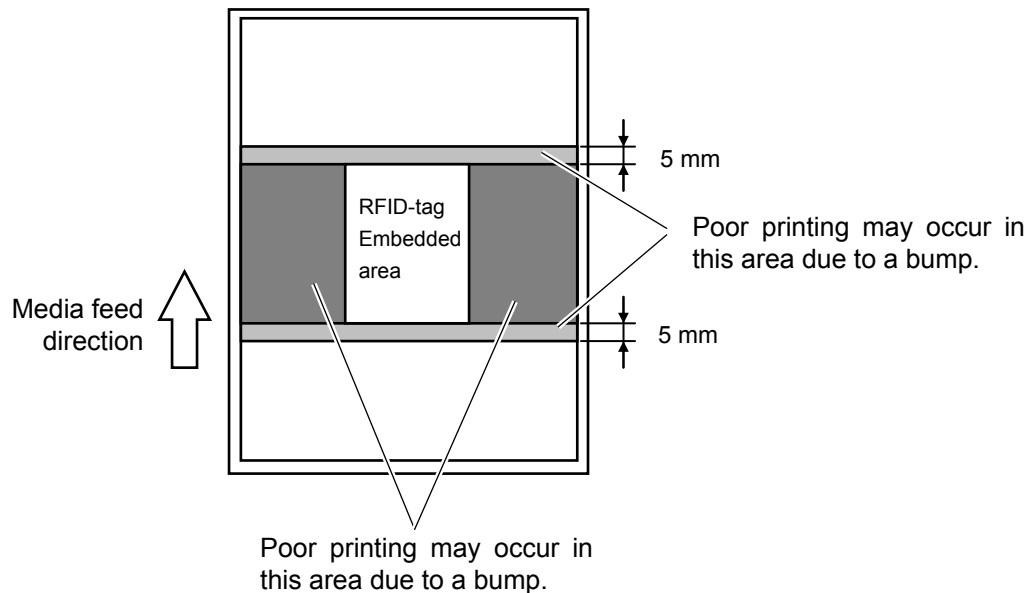
**(8) Ambient Temperature**

As low temperatures cause wireless performance to deteriorate, writing data on an RFID tag may fail under such conditions.

(9) Strip Issue

Stripping performance in strip issue mode depends on the type of adhesive, tag, and backing paper. For some RFID supplies used, a strip issue may not be performed properly.

(10) Caution for Minimum Label Pitch Length

When using media, with a short label pitch length, data may be written on an RFID tag adjacent to the target RFID tag.

As the location, where data is to be written, differs among RFID tag types, a check must be performed to make sure that the data is written on the target RFID tags. The B-EX RFID Analyze Tool can be used for this purpose. For details, please contact the nearest TOSHIBA TEC support representative.

(11) Defective RFID Supply

RFID supplies may include defective RFID tags at the time of shipment from the maker. The defect rate differs depending on tag types, method of converting to supplies, etc.

The RFID supply manufacturer should provide a way to identify defective tags by printing a mark on them or any other methods.

Or, defective tags should be rejected in the production process.

The end users must be notified on how to identify a defective tag from a good one.

7.2 Ribbon

The approved ribbon must be used.

Use of any non-approved ribbon may cause problems.

A. SHAPE AND SIZE OF RIBBON

| No. | Item | Specification | |
|-----|----------------------|--|-------------|
| 1 | Ribbon Shape | Spool type | |
| 2 | Ribbon Width | 68(40) ± 1 mm to 112 mm | |
| | Ribbon Winding Width | 68(40) $^{+2}_{-1}$ mm to 112 mm | |
| 3 | Max. Ribbon Length | 600 m ($\varnothing 90$ mm or less) | |
| 4 | Max. Ribbon OD | $\varnothing 90$ mm (Outside wound), $\varnothing 80$ mm (Inside wound) | |
| 5 | Back Treatment | Coated | |
| 6 | Ribbon Core | Material | Paper |
| | | Shape | See Fig. 1. |
| 7 | Leader Tape | Polyester film (silver), 300 \pm 5 mm long | |
| 8 | End Tape | Polyester film (silver), 250 \pm 5 mm long | |
| 9 | Winding Method | The ribbon is wound outside. For the core and ribbon winding positions, see Fig. 2. | |

NOTES:

- The ribbon type number and the lot No. should be marked on the ribbon core end with black indelible ink. (If doing this is impossible, separately specify the location where the type number and the lot number are stamped.)
- It is recommended that the ribbon is wider than the paper width by 5 mm or more.
 - When the difference between the ribbon width and the paper width is same or too minimum, the ribbon may wrinkle.
 - When the difference between the ribbon width and the paper width is too large, the ribbon may wrinkle.
 - Be careful of the upper limit of the ribbon width.
- The ribbon which is narrower than the paper width by 5 mm or more can be used, but the print area becomes narrower.

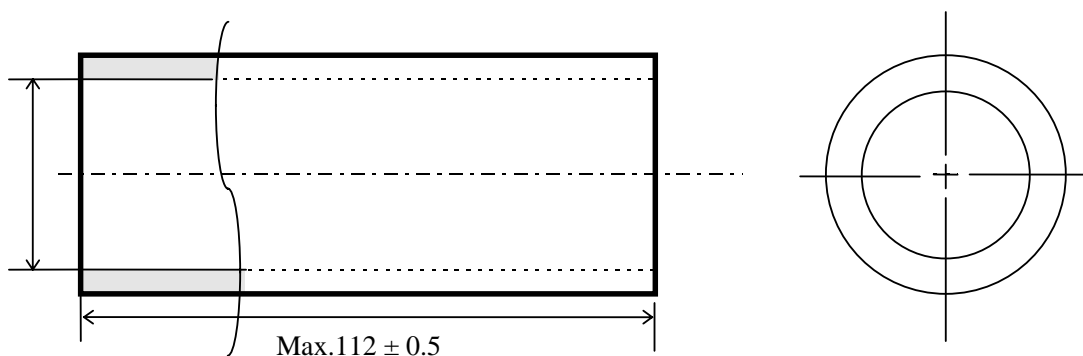

Positional Relationship between Core and Ribbon

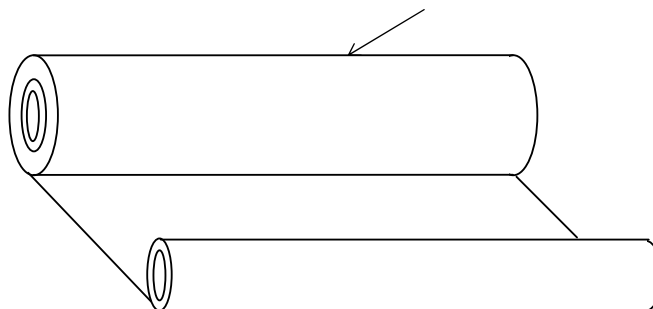

NOTE: Wind the ink ribbon so that the ribbon center aligns with the core center.

Fig. 3: Connection between Leader Tape and Ribbon

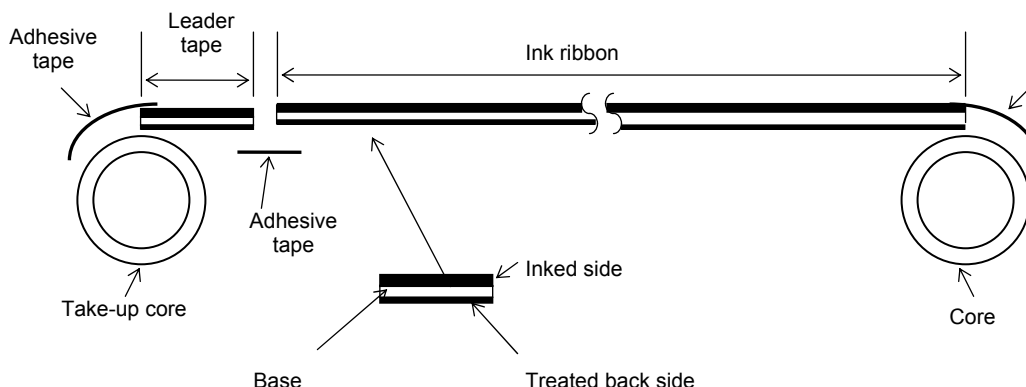

NOTES on using ribbon:

If the difference between the ribbon width and the paper width is too large, the ribbon may wrinkle. Refer to the table below and choose the paper appropriate to the ribbon width. Even if the ribbon is narrower than paper, printing can be performed. However, it results in the narrower print range.

B-EX4T Type2 series

| Ribbon width | 41mm | 50mm | 68mm | 84mm | 112mm |
|-------------------------|-------------|-------------|-------------|-------------|--------------|
| Appropriate paper width | 30 to 36 mm | 36 to 45 mm | 45 to 63 mm | 63 to 79 mm | 79 to 108 mm |

The ribbon tension adjustment may be further required according to the ribbon width. In the case a narrower width of the ribbon is used, if the ribbon tension is strong, the ribbon will wrinkle. According to the print patterns, fine adjustment of the ribbon take-up motor is required. As a guide, regardless of the print speed, it should be set to “-3” (FW) and “-1” (BK) for 68-mm wide ribbon, and “-4” (FW) and “-2” (BK) for 50-mm wide or less ribbon, respectively.

7.3 Recommended Media and Ribbon Types

APPROVED PAPER

| Type | Item Code | Manufacturer Type No. | Paper Thickness (μm) | Manufacturer | Remarks | |
|-------|-----------------------|-----------------------|----------------------|--------------|------------------------|--------|
| Label | Direct thermal type | 150LA-1P | 82 | RICOH | | |
| | | Vellum | | Rafalac | (Uncoated) | |
| | | Transtherm 1C | | Fasson | (Coated, gloss) | |
| | Thermal transfer type | | VES-85 | 85 | OSAKA SEALING PRINTING | (Yupo) |
| | | FR1412-50 | White PET | 50 | LINTEC | |
| | | FR1615-50 | Silver chemical mat | 50 | LINTEC | |
| | | | | | | |
| Tag | Direct thermal type | 130LAB-1-150 | 150 | RICOH | T.B.D | |
| | | | | | | |
| | | | | | | |
| | Thermal transfer type | IS50 | I-BEST S | 164 | OSAKA SEALING PRINTING | |
| | | | | | | |

NOTE:

1. The print head life varies depending on the print pattern (printing ratio).
2. Transmissive sensor is initially adjusted with Vellum label, and the Reflective sensor is adjusted with I-BEST S tag. When using other Label/Tag, it may be necessary to adjust sensor. When occurring Feed Error, adjust sensor with using Label/Tag. For details regarding the sensor adjustment, refer to Section 2.11 Sensor Setting.

APPROVED RIBBONS

Type: W: Wax SR: Semi-resin R: Resin

| Item Code (Global) | Base Thickness (µm) | Type | Remarks | Applicable models (indicated with ○) | | |
|-----------------------|---------------------------|------|---------|---|---|---|
| | | | | G | T | H |
| BEX-****AW3 | 4.5 | W | | ○ | ○ | |
| BEX-****AW5 | 4.5 | W | T.B.D | ○ | ○ | |
| BEX-****AW6F | 4.5 | W | | ○ | ○ | |
| BEX-****AW7F | 4.5 | W | | ○ | ○ | |
| BEX-****AG3 | 4.5 | SR | | ○ | ○ | |
| BEX-****AG4 | 4.5 | SR | T.B.D | ○ | ○ | |
| BEX-****AS1 | 4.5 | R | | ○ | ○ | ○ |
| BEX-****AS2 | 4.5 | R | T.B.D | ○ | ○ | ○ |
| | | | | | | |
| BEX-****RG2 | 4.5 | SR | T.B.D | ○ | ○ | |
| | 4.5 | SR | T.B.D | ○ | ○ | |
| BEX-****RS1 | 4.5 | R | T.B.D | ○ | ○ | ○ |
| | 4.5 | R | T.B.D | ○ | ○ | ○ |
| | | | | | | |
| BEX-****SW1 | 4.5 | W | | ○ | ○ | |
| BEX-****SG3F | 4.5 | SR | T.B.D | ○ | ○ | |
| BEX-****SG4F | 4.5 | SR | T.B.D | ○ | ○ | |
| BEX-****SS2F | 4.5 | R | T.B.D | ○ | ○ | ○ |
| BEX-****SS3F | 4.5 | R | T.B.D | ○ | ○ | ○ |
| | | | | | | |

NOTE:

1. Print conditions and paper to be used may differ for each ribbon.

PRINT TONE FINE ADJUSTMENT VALUES BY SUPPLIES

For 203dpi model

| Print Mode | Ribbon | Paper | Print speed | | | | Print energy type | Remarks |
|-----------------------|--------------|----------|-------------|-------|----------|----------|-------------------|--|
| | | | 3"/s | 6"/s | 10"/s | 12"/s | | |
| Thermal transfer type | BEX-****AW3 | Vellum | -2 | -2 | -2 | +2 | Wax1 | This combination is not acceptable in the case of 10, 12ips and high temperature environment. |
| | | TT1C | 0 | 0 | +2 | +2 | Wax1 | In the case of 10, 12ips and low temperature environment requires a print tone adjustment to positive direction. |
| | | I-BEST S | -2 | 0 | +4 | +6 | Wax1 | Serial bar code printed at 12ips is unusable. |
| | BEX-****AW6F | Vellum | -4 | -4 | 0 | +2 | Wax1 | In the case of 3, 6ips and high temperature environment requires a print tone adjustment to negative direction. |
| | | TT1C | -6 | -4 | +2 | +4 | Wax1 | |
| | | I-BEST S | -4 | -4 | +2 | +4 | Wax1 | |
| | BEX-****AW7F | Vellum | -8 | -4 | +2 | unusable | Wax1 | In the case of 3, 6ips and high temperature environment requires a print tone adjustment to negative direction. This combination is not acceptable in the case of 10ips and high temperature environment. |
| | | TT1C | -6 | -4 | +6 | +6 | Wax1 | In the case of 3, 6ips and high temperature environment requires a print tone adjustment to negative direction. |
| | | I-BEST S | -4 | -2 | unusable | | Wax1 | In the case of 3ips and high temperature environment requires a print tone adjustment to negative direction. |
| | BEX-****AG3 | Vellum | 0 | 0 | +4 | +6 | Semi-resin1 | In the case of 6ips and low temperature environment requires a print tone adjustment to positive direction. This combination is not acceptable in the case of 10, 12ips and high temperature environment. |
| | | TT1C | +2 | +4 | +6 | unusable | Semi-resin1 | |
| | | VES-85 | -4 | T.B.D | +2 | +2 | Semi-resin1 | |
| | | I-BEST S | 0 | 0 | +4 | unusable | Semi-resin1 | |

| Print Mode | Ribbon | Paper | Print speed | | | | Print energy type | Remarks |
|-----------------------|-------------|-----------|-------------|------|----------|----------|-------------------|---|
| | | | 3"/s | 6"/s | 10"/s | 12"/s | | |
| Thermal transfer type | BEX-****AS1 | FR1412-50 | +6 | +4 | unusable | | Resin1 | |
| | | FR1615-50 | +2 | +2 | unusable | | Resin1 | |
| | BEX-****SW1 | Vellum | -4 | -6 | 0 | +2 | Wax1 | This combination is not acceptable in the case of all print speed and high temperature environment. |
| | | TT1C | -4 | -2 | +4 | +6 | Wax1 | |
| | | I-BEST S | 0 | 0 | +4 | unusable | Wax1 | |
| Direct thermal type | | 150LA-1P | 0 | 0 | 0 | 0 | Standard | |
| | | | | | | | | |

NOTES:

- *1: Since the print tones provided in the above table are the recommended values, the variance should be taken into consideration when in use.
- *2: The print energy type must be set the above table by all means. For setting method of the print energy type, refer to Section 2.6.2.2 Software Set.
- *3: It limits print tone fine adjustment for the protection of thermal head by the rating of the maximum supply energy of thermal head. The tone of printing do not thicken even if it is set print tone fine adjustment value more than the value of the list shown below.

| Print energy type | Print tone fine adjustment limit | | | |
|-------------------|----------------------------------|------|-------|-------|
| | 3"/s | 6"/s | 10"/s | 12"/s |
| Standard | +10 | +10 | +10 | +6 |
| Wax1 | +10 | +10 | +3 | -1 |
| Wax2 | +10 | +10 | +3 | -1 |
| Semi-resin1 | +10 | +10 | +10 | +3 |
| Semi-resin2 | +10 | +10 | +3 | -1 |
| Resin1 | +10 | +10 | +4 | -1 |
| Wax3 | +10 | +10 | -1 | -1 |
| Semi-resin3 | +10 | +10 | +3 | -1 |
| Resin2 | +10 | +5 | 0 | -1 |

For 300dpi model

| Print Mode | Ribbon | Paper | Print speed | | | | | Print energy type | Remarks |
|-----------------------|---------------|-----------|-------------|------|------|----------|----------|-------------------|---|
| | | | 3"/s | 5"/s | 8"/s | 10"/s | 12"/s | | |
| Thermal transfer type | BEX-*****AW3 | Vellum | +4 | 0 | +4 | +6 | Unusable | Wax1 | In the case of 3, 5, 8ips and high temperature environment requires a print tone adjustment to negative direction. |
| | | TT1C | +4 | +2 | +6 | Unusable | | Wax1 | In the case of 8ips and low temperature environment requires a print tone adjustment to positive direction. In the case of 8ips and high temperature environment requires a print tone adjustment to negative direction. |
| | | I-BEST S | Unusable | | | | | Wax1 | |
| | BEX-*****AW6F | Vellum | -4 | -2 | +6 | Unusable | | Wax1 | In the case of 3, 5, 8ips and high temperature environment requires a print tone adjustment to negative direction. |
| | | TT1C | -2 | -2 | 0 | 0 | Unusable | Wax1 | In the case of 3, 5ips and high temperature environment requires a print tone adjustment to negative direction. |
| | | I-BEST S | -2 | 0 | +2 | +2 | Unusable | Wax1 | In the case of 3ips and high temperature environment requires a print tone adjustment to negative direction. |
| | BEX-*****AW7F | Vellum | Unusable | | | | | Wax1 | |
| | | TT1C | 0 | 0 | +2 | +2 | Unusable | Wax1 | |
| | | I-BEST S | Unusable | | | | | Wax1 | |
| | BEX-*****AG3 | Vellum | +2 | +2 | +4 | +6 | Unusable | Semi-resin1 | |
| | | TT1C | +2 | +4 | +6 | +6 | Unusable | Semi-resin1 | |
| | | VES-85 | -2 | 0 | -2 | -2 | 0 | Semi-resin1 | |
| | | I-BEST S | 0 | +4 | +4 | +4 | Unusable | Semi-resin1 | |
| | BEX-*****AS1 | FR1412-50 | 0 | +4 | +6 | Unusable | | Resin1 | |
| | | FR1615-50 | +2 | +4 | +6 | Unusable | | Resin1 | |
| | BEX-*****SW1 | Vellum | +4 | +4 | +4 | Unusable | | Wax1 | In the case of 3, 5, 8ips and high temperature environment requires a print tone adjustment to negative direction. |
| | | TT1C | +2 | +4 | +4 | +4 | Unusable | Wax1 | |
| | | I-BEST S | Unusable | | | | | Wax1 | |

| Print Mode | Ribbon | Paper | Print speed | | | | | Print energy type | Remarks |
|---------------------|--------|----------|-------------|------|------|-------|-------|-------------------|---------|
| | | | 3"/s | 5"/s | 8"/s | 10"/s | 12"/s | | |
| Direct Thermal type | | 150LA-1P | 0 | 0 | 0 | 0 | 0 | Standard | |
| | | | | | | | | | |
| | | | | | | | | | |

NOTES:

- *1: Since the print tones provided in the above table are the recommended values, the variance should be taken into consideration when in use.
- *2: The print energy type must be set the above table by all means. For setting method of the print energy type, refer to the Key Operation Specification.
- *3: It limits print tone fine adjustment for the protection of thermal head by the rating of the maximum supply energy of thermal head. The tone of printing do not thicken even if it is set print tone fine adjustment value more than the value of the list shown below.

| FEAAPrint energy type | Print tone fine adjustment limit | | | | |
|-----------------------|----------------------------------|------|------|-------|-------|
| | 3"/s | 5"/s | 8"/s | 10"/s | 12"/s |
| Standard | +10 | +10 | +10 | +10 | +6 |
| Wax1 | +10 | +10 | +9 | +2 | -4 |
| Wax2 | +10 | +10 | +9 | +2 | -4 |
| Semi-resin1 | +10 | +10 | +10 | +8 | 0 |
| Semi-resin2 | +10 | +10 | +8 | +1 | -5 |
| Resin1 | +10 | +10 | +10 | +4 | 0 |
| Wax3 | +10 | +10 | +3 | -3 | -2 |
| Semi-resin3 | +10 | +10 | +3 | -2 | 0 |
| Resin2 | +10 | +10 | 0 | -2 | 0 |

For 600dpi model

| Print Mode | Ribbon | Paper | Print speed | | | | | Print energy type | Remarks |
|-----------------------|--------------|-----------|-------------|------|------|------|------|-------------------|---------|
| | | | 2"/s | 3"/s | 4"/s | 5"/s | 6"/s | | |
| Thermal transfer type | BEX-*****AS1 | FR1412-50 | +6 | +6 | +6 | +6 | +6 | Resin1 | |
| | | FR1615-50 | +4 | +2 | +4 | +6 | +2 | Resin1 | |
| Direct thermal type | | 150LA-1P | 0 | 0 | 0 | 0 | 0 | Standard | |
| | | | | | | | | | |

NOTES:

- *1: Since the print tones provided in the above table are the recommended values, the variance should be taken into consideration when in use.
- *2: The print energy type must be set the above table by all means. For setting method of the print energy type, refer to the Key Operation Specification.
- *3: It limits print tone fine adjustment for the protection of thermal head by the rating of the maximum supply energy of thermal head. The tone of printing do not thicken even if it is set print tone fine adjustment value more than the value of the list shown below.

| Print energy type | Print tone fine adjustment limit | | | | |
|-------------------|----------------------------------|------|------|------|------|
| | 2"/s | 3"/s | 4"/s | 5"/s | 6"/s |
| Standard | +10 | +10 | +10 | +10 | +10 |
| Resin1 | +10 | +10 | +10 | +10 | +9 |
| Resin2 | +10 | +10 | +10 | +6 | 0 |

7.4 Care/Handling of Media and Ribbon

CAUTION!

Be sure to carefully review and understand the Supply Manual. Use only media and ribbons that meet specified requirements. Use of non-specified media and ribbons may shorten the head life and result in problems with bar code readability or print quality. All media and ribbons should be handled with care to avoid any damage to the media, ribbons or printer. Read the guidelines in this section carefully.

- Do not store the media or ribbon for longer than the manufacturer's recommended shelf life.
- Store media rolls on the flat end. Do not store them on the curved sides as this might flatten that side causing erratic media advance and poor print quality.
- Store the media in plastic bags and always reseal after opening. Unprotected media can get dirty and the extra abrasion from the dust and dirt particles will shorten the print head life.
- Store the media and ribbon in a cool, dry place. Avoid areas where they would be exposed to direct sunlight, high temperature, high humidity, dust or gas.
- The thermal paper used for direct thermal printing must not have specifications which exceed Na⁺ 800 ppm, K⁺ 250 ppm and Cl⁻ 500 ppm.
- Some ink used on pre-printed media may contain ingredients which shorten the print head's product life. Do not use labels pre-printed with ink which contain hard substances such as carbonic calcium (CaCO₃) and kaolin (Al₂O₃, 2SiO₂, 2H₂O).

For further information, please contact your local distributor or your media and ribbon manufacturers.

APPENDIX 1 MESSAGES AND LEDS

Appendix 1 describes the LCD messages displayed on the operation panel.

Symbols in the message

1: ○: The LED is illuminated. ⊙: The LED is flashing. ●: The LED is unlit.

2: %%,%%%,%%%: Remaining memory size of the external memory: 0 to 09,999,999 (in K bytes)

3: #####: Remaining memory size for PC commands storage area in the internal memory: 0 to 3072 (in K bytes)

4: &&&&: Remaining memory size for writable characters storage area: 0 to 3147 (in K bytes)

| No. | LCD Message | LED Indicator | | Printer Status | Restoration by RESTART key Yes/No | Acceptance of Status Request/Reset Command Yes/No |
|-----|--|---------------|-------|---|--------------------------------------|--|
| | | ONLINE | ERROR | | | |
| 1 | ON LINE | ○ | ● | In online mode | ---- | Yes |
| | ON LINE | ⊙ | ● | In online mode (The printer is communicating) | ---- | Yes |
| 2 | HEAD OPEN | ● | ● | The print head block is open in online mode. | ---- | Yes |
| 3 | PAUSE | ● | ● | The printer is paused. | Yes | Yes |
| 4 | COMMS ERROR | ● | ○ | A parity, overrun, or framing error has occurred during communication through the RS-232C. | Yes | Yes |
| 5 | PAPER JAM | ● | ○ | The media is jammed during paper feed. | Yes | Yes |
| 6 | CUTTER ERROR | ● | ○ | A problem has occurred with the cutter module. | Yes | Yes |
| 7 | NO PAPER | ● | ○ | The media has run out, or the media is not loaded properly. | Yes | Yes |
| 8 | NO RIBBON | ● | ○ | The ribbon has run out. | Yes | Yes |
| 9 | HEAD OPEN | ● | ○ | Feed or printing was attempted with the print head block open. | Yes | Yes |
| 10 | HEAD ERROR | ● | ○ | There is a problem with the print head. | Yes | Yes |
| 11 | EXCESS HEAD TEMP | ● | ○ | The print head has overheated. | No | Yes |
| 12 | RIBBON ERROR | ● | ○ | The ribbon has been torn. A problem has occurred with the sensor that determines the torque for the ribbon motor. | Yes | Yes |
| 13 | REWIND FULL | ● | ○ | An overflow error has occurred in the rewind unit. | Yes | Yes |
| 14 | SAVING#####KB&&&&KB or SAVING%,%%%,%%%,%%%KB | ○ | ● | Writable character or PC command save mode | ---- | Yes |
| 15 | FORMAT#####KB&&&&KB or FORMAT%,%%%,%%%,%%%KB | ○ | ● | The storage area is being initialised. | ---- | Yes |
| 16 | NOW LOADING... | ○ | ● | TrueType font or BASIC program is being downloaded. | ---- | Yes |
| 17 | MEMORY WRITE ERR. | ● | ○ | An error has occurred while writing to flash memory or USB memory. | No | Yes |
| 18 | FORMAT ERROR | ● | ○ | An erase error has occurred while formatting the flash memory or USB memory. | No | Yes |
| 19 | MEMORY FULL | ● | ○ | Data cannot be stored because the flash memory or USB memory is full. | No | Yes |

| No. | LCD Message | LED Indicator | | Printer Status | Restoration by RESTART key Yes/No | Acceptance of Status Request/ Reset Command Yes/No |
|-----|--|---------------|-------|--|---|---|
| | | ONLINE | ERROR | | | |
| 20 | Display of error message (See Notes.) | ● | ○ | A command error has occurred while analyzing the command. | Yes | Yes |
| 21 | POWER FAILURE | ● | ○ | A power failure has occurred. | No | No |
| 22 | EEPROM ERROR | ● | ○ | Data cannot be read from/written to a backup EEPROM properly | No | No |
| 23 | SYSTEM ERROR | ● | ○ | When the following abnormal operations are performed, a system error occurs: (a) Command fetch from an incorrect address. (b) Access to word data at an incorrect address. (c) Access to long-word data at an incorrect address. (d) Access to the area of 80000000H to FFFFFFFFH in the logic space in user mode. (e) An undefined instruction in an area other than a delay slot was decoded. (f) An undefined instruction in a delay slot was decoded. (g) An instruction to rewrite a delay slot was decoded. | No | No |
| 24 | DHCP CLIENT INIT... | ● | ● | DHCP Client is being initialised. (Only when the DHCP is enabled.) | ---- | ---- |
| 25 | RFID WRITE ERROR | ● | ○ | The printer did not succeed in writing data onto an RFID tag after having retried the specified number of times. | Yes | Yes |
| 26 | RFID ERROR | ● | ○ | The printer cannot communicate with the RFID module. | No | Yes |
| 27 | LOW BATTERY | ● | ○ | The voltage of the Real Time Clock Battery is low. | No | Yes |
| 28 | INPUT PASSWORD | ● | ● | The printer is waiting for a password to be entered. | No | No |
| 29 | PASSWORD INVALID Please Power OFF | ● | ● | A wrong password was entered three consecutive times. | No | No |
| 30 | INTERNAL COM ERR | ● | ● | A hard error occurred in internal serial interface. | No | No |
| | | | | | | |

NOTE: When an error message listed above appears on the LCD display please refer to **Section 5 TROUBLESHOOTING** for a solution.

NOTES:

- If an error is found in a command received, up to 42 bytes of the erroneous command, starting from the command code, will be displayed. (However, [LF] and [NUL] will not be displayed.)

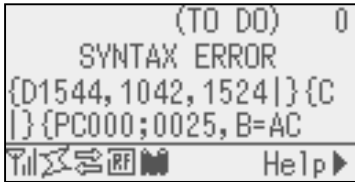

Example 1

[ESC]PC001;0A00,0300,2,2,A,00,B[LF][NUL]

↑ Command error

The following message appears.

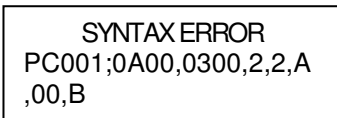

Example 2

[ESC]T20G30[LF] [NUL]

↑ Command error

The following message appears.

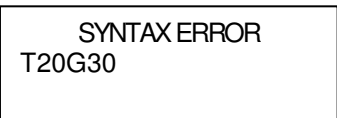

Example 3

[ESC]PC002;0100,0300,15,15,A,00,00,J0101,+000000000A,Z10,P1[LF] [NUL]

↑ Command error

The following message appears.

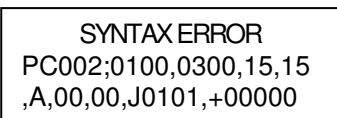

- When the error is shown, “?” (3FH)” appears for character codes other than 20H to 7FH and A0H to DFH.
- For details, please refer to the **B-EX4T/EX6T Series External Equipment Interface Specification**.

APPENDIX 2 INTERFACE

NOTE:

To prevent radiation and reception of electrical noise, the interface cables must meet the following requirements:

- In case of a parallel interface cable or serial interface cable, fully shielded and fitted with metal or metallised connector housings.
- Keep as short as possible.
- Should not be bundled tightly with power cords.
- Should not be tied to power line conduits.
- A parallel interface cable to be used should conform to IEEE1284.

■ USB interface (Standard)

Physical Layer: Conforming to V2.0 Full speed
 Transfer type: Control transfer, Bulk transfer
 Transfer rate: Full speed (12M bps)
 Class: Printer class
 Number of ports: 1
 Power source: Self power
 Connector: Type B

| Pin No. | Signal |
|---------|--------|
| 1 | VCC |
| 2 | D- |
| 3 | D+ |
| 4 | GND |

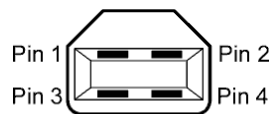

Series B Plug

■ LAN (Standard)

Physical Layer: IEEE802.3 10BASE-T/100BASE-TX
 Number of ports: 1
 Connector: RJ-45
 LED status: Link LED, Activity LED

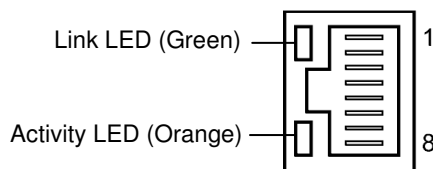

| LED | LED Status | LAN status |
|----------|------------|---|
| Link | ON | 10Mbps link or 100Mbps link is detected. |
| | OFF | No link is detected. * Communication cannot be made while the Link LED is off. |
| Activity | ON | Communicating |
| | OFF | Idle |

LAN cable: 10BASE-T: UTP category 3 or category 5
 100BASE-TX: UTP category 5
 Cable length: Segment length Max. 100 m

NOTE:

When a generally-used twisted pair Ethernet (TPE) or UTP cable is used, a communication error may occur depending on your operating environment. In such case, you may be requested to use a shielded twisted pair cable.

■ **Serial interface (Option: B-EX700-RS-QM-R)**

Type: RS-232C
 Communication mode: Full duplex
 Transmission speed: 2400 bps, 4800 bps, 9600 bps, 19200 bps, 38400 bps, 115200 bps
 Synchronization: Start-stop synchronization
 Start bit: 1 bit
 Stop bit: 1 bit, 2 bit
 Data length: 7 bit, 8 bit
 Parity: None, EVEN, ODD
 Error detection: Parity error, Framing error, Overrun error
 Protocol: Unprocedure communication
 Data input code: ASCII code, European character 8 bit code, graphic 8 bit code, JIS8 code, Shift JIS Kanji code, JIS Kanji code
 Receive buffer: 1M byte
 Connector:

| Pin No. | Signal |
|---------|---------------------------|
| 1 | N.C |
| 2 | TXD (Transmit Data) |
| 3 | RXD (Received Data) |
| 4 | DSR (Data Set Ready) |
| 5 | SG (Signal Ground) |
| 6 | DTR (Data Terminal Ready) |
| 7 | CTS (Clear to Send) |
| 8 | RTS (Request to Send) |
| 9 | N.C |

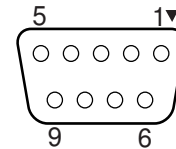

■ **Parallel interface (Centronics) (Option: B-EX700-CEN-QM-R)**

Mode: Conforming to IEEE1284
 Compatible mode (SPP mode), Nibble mode
 Data input method: 8 bit parallel
 Control signal:

| SPP Mode | Nibble Mode | ECP Mode |
|-----------|----------------|-----------------|
| nStrobe | HostClk | HostClk |
| nAck | PtrClk | PeriphClk |
| Busy | PtrBusy | PeriphAck |
| Perror | AckDataReq | NAckReverse |
| Select | Xflag | Xflag |
| nAutoFd | HostBusy | HostAck |
| nInIt | nInIt | nReverseRequest |
| nFault | nDataAvail | nPeriphRequest |
| nSelectIn | IEEE1284Active | IEEE1284Active |

Data input code: ASCII code
 European 8 bit code
 Graphic 8 bit code
 JIS8 code
 Shift JIS Kanji code
 JIS Kanji code
 Receive buffer: 1MB

Connector:

| PIN No. | Signal | | |
|---------|-------------------------|-------------------------|-------------------------|
| | SPP Mode | Nibble Mode | ECP Mode |
| 1 | nStrobe | HostClk | HostClk |
| 2 | Data 1 | Data 1 | Data 1 |
| 3 | Data 2 | Data 2 | Data 2 |
| 4 | Data 3 | Data 3 | Data 3 |
| 5 | Data 4 | Data 4 | Data 4 |
| 6 | Data 5 | Data 5 | Data 5 |
| 7 | Data 6 | Data 6 | Data 6 |
| 8 | Data 7 | Data 7 | Data 7 |
| 9 | Data 8 | Data 8 | Data 8 |
| 10 | nAck | PtrClk | PeriphClk |
| 11 | Busy | PtrBusy | PeriphAck |
| 12 | PError | AckDataReq | nAckReverse |
| 13 | Select | Xflag | XFlag |
| 14 | nAutoFd | HostBusy | HstAck |
| 15 | NC | NC | NC |
| 16 | 0V | 0V | 0V |
| 17 | CHASSIS GND | CHASSIS GND | CHASSIS GND |
| 18 | +5V (For detection) | +5V (For detection) | +5V (For detection) |
| 19 | TWISTED PAIR GND(PIN1) | TWISTED PAIR GND(PIN1) | TWISTED PAIR GND(PIN1) |
| 20 | TWISTED PAIR GND(PIN2) | TWISTED PAIR GND(PIN2) | TWISTED PAIR GND(PIN2) |
| 21 | TWISTED PAIR GND(PIN3) | TWISTED PAIR GND(PIN3) | TWISTED PAIR GND(PIN3) |
| 22 | TWISTED PAIR GND(PIN4) | TWISTED PAIR GND(PIN4) | TWISTED PAIR GND(PIN4) |
| 23 | TWISTED PAIR GND(PIN5) | TWISTED PAIR GND(PIN5) | TWISTED PAIR GND(PIN5) |
| 24 | TWISTED PAIR GND(PIN6) | TWISTED PAIR GND(PIN6) | TWISTED PAIR GND(PIN6) |
| 25 | TWISTED PAIR GND(PIN7) | TWISTED PAIR GND(PIN7) | TWISTED PAIR GND(PIN7) |
| 26 | TWISTED PAIR GND(PIN8) | TWISTED PAIR GND(PIN8) | TWISTED PAIR GND(PIN8) |
| 27 | TWISTED PAIR GND(PIN9) | TWISTED PAIR GND(PIN9) | TWISTED PAIR GND(PIN9) |
| 28 | TWISTED PAIR GND(PIN10) | TWISTED PAIR GND(PIN10) | TWISTED PAIR GND(PIN10) |
| 29 | TWISTED PAIR GND(PIN11) | TWISTED PAIR GND(PIN11) | TWISTED PAIR GND(PIN11) |
| 30 | TWISTED PAIR GND(PIN31) | TWISTED PAIR GND(PIN31) | TWISTED PAIR GND(PIN31) |
| 31 | nInit | nInit | nReverseRequest |
| 32 | nFault | NDataAvail | nPeriphRequest |
| 33 | 0V | 0V | 0V |
| 34 | NC | NC | NC |
| 35 | NC | NC | NC |
| 36 | nSelectIn | IEEE1284Active | IEEE1284Active |

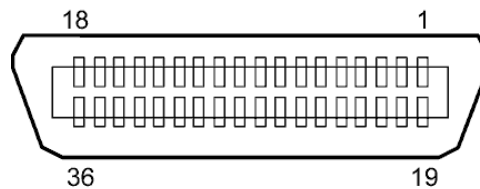

IEEE1284-B Connector

■ Wireless LAN (Option: B-EX700-WLAN-QM-R)

| | |
|----------------------|---|
| Standard: | Conforming to IEEE802.11b, and IEEE802.11g |
| Client protocol: | TCP/IP, Socket, LPD (LLPR), DHCP/WINS, HTTPD (SNMP) |
| Print protocol: | Socket communication/LPR |
| Security protocol: | WEP (64 bits/128 bits) or AES, TKIP (only when using WPA, WPA-PSK) Shared key (for WEP), PSK, PEAP, TLS, TTLS, MD5, LEAP, EAP-FAST |
| Antenna: | Built-in |
| Parameter setting: | via USB, LAN, WLAN, RS-232C, Parallel |
| Default IP address: | 192.168.10.21 |
| Default subnet mask: | 255.255.255.0 |
| Certification: | Wi-Fi, CCX V3, V4 |

NOTE:

MAC address of the Wireless LAN module will be necessary when setting the MAC address filtering function of an access point. Please ask a service person of your nearest TOSHIBA TEC service representative.

■ USB Host interface (Option: B-EX700-RTC-QM-R)

| | |
|------------------|---------------------------------|
| Physical Layer: | Conforming to V2.0 Full speed |
| Transfer type: | Control transfer, Bulk transfer |
| Transfer rate: | Full speed (12M bps) |
| Number of ports: | 1 |
| Power supply: | 50mA output |
| Connector: | Type A |

■ Expansion I/O Interface (Option: B-EX700-IO-QM-R)

Input Signal IN0 to IN5
 Output Signal OUT0 to OUT6
 Connector FCN-781P024-G/P or equivalent
 (External Device Side)
 Connector FCN-685J0024 or equivalent
 (Printer Side)

| Pin | Signal | I/O | Function | Pin | Signal | I/O | Function |
|-----|--------|--------|----------|-----|--------|-----------------|----------|
| 1 | IN0 | Input | FEED | 13 | OUT6 | Output | |
| 2 | IN1 | Input | PRINT | 14 | N.C. | ---- | |
| 3 | IN2 | Input | PAUSE | 15 | COM1 | Common (Power) | |
| 4 | IN3 | Input | | 16 | N.C. | ---- | |
| 5 | IN4 | Input | | 17 | N.C. | ---- | |
| 6 | IN5 | Input | | 18 | N.C. | ---- | |
| 7 | OUT0 | Output | FEED | 19 | N.C. | ---- | |
| 8 | OUT1 | Output | PRINT | 20 | N.C. | ---- | |
| 9 | OUT2 | Output | PAUSE | 21 | COM2 | Common (Ground) | |
| 10 | OUT3 | Output | ERROR | 22 | N.C. | ---- | |
| 11 | OUT4 | Output | | 23 | N.C. | ---- | |
| 12 | OUT5 | Output | POWER ON | 24 | N.C. | ---- | |

N.C.: No Connection

Input Circuit

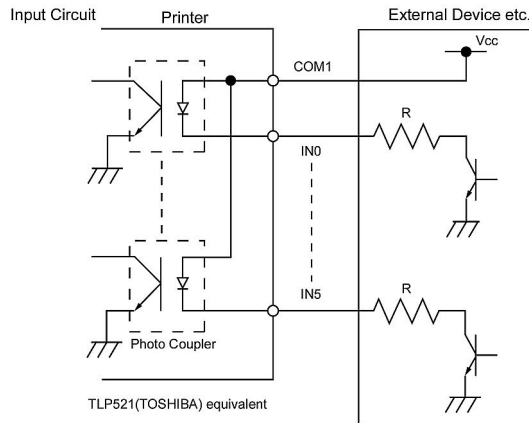

Output Circuit

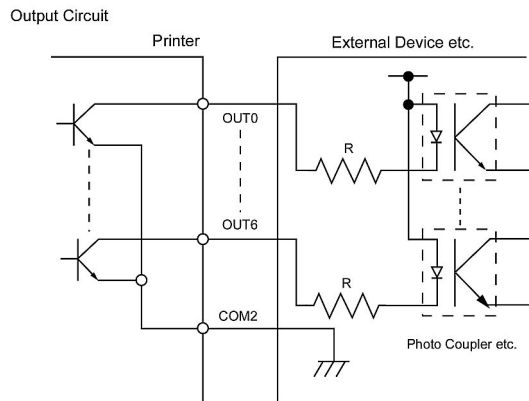

Operating environment Temperature: 0 to 40 °C
 Humidity: 20 to 90% (No Condensation)

■ RFID (Option)**• B-EX700-RFID-H1-QM-R**

| | |
|---------------------|---|
| Module: | TagSysm MEDIO S002 /S003 (Not included in this optional kit.) |
| Frequency: | 13.56MHz |
| Output: | 200 mW |
| Available RFID tag: | TagSys C210, C220, C240, C320 I-Code, Tag-it, ISO15693 |
| Antenna: | RF antenna is not included in this optional kit. |

APPENDIX 3 PRINT SAMPLES

■ Font

<A>Times Roman medium

Times Roman medium

<C>Times Roman bold

<D>Times Roman bold

<E>Times Roman bold

<F>*Times Roman italic*

<G>Helvetica medium

<H>Helvetica medium

<I>Helvetica medium

<J>Helvetica bold

<K>Helvetica bold

<L>*Helvetica italic*

<M>**PRESENTATION BOLD**

<N>Letter Gothic medium

<O>Prestige Elite medium

<P>Prestige Elite bold

<Q>Courier medium

<R>Courier bold

<S>OCR-A

<T>OCR-B

<q>Gothic 725 Black

<Outline Font:A> **H e l v e t i c a b o l d**

<Outline Font:B> **Helvetica bold(P)**

<Outline Font:E> *0 1 2 3 4 5 6 7 8 9, y \$*

<Outline Font:F> **0 1 2 3 4 5 6 7 8 9, ¥ \$**

<Outline Font:G> **0 1 2 3 4 5 6 7 8 9, ¥ \$**

<Outline Font:H> **Dutch 801 bold**

<Outline Font:I> *Brush 738 regular*

<Outline Font:J> **Gothic 725 Black**

APPENDIX 3 PRINT SAMPLES (Cont.)

■ Bar codes

JAN8, EAN8



Interleaved 2 of 5



NW7



UPC-E



EAN13+5 digits



CODE39 (Full ASCII)



UPC-E+2 digits



EAN8+2 digits



UPC-A



MSI



CODE39 (Standard)



JAN13, EAN13



EAN13+2 digits



CODE128



CODE93



UPC-E+5 digits



EAN8+5 digits



UPC-A+2 digits



UPC-A+5 digits



UCC/EAN128



Industrial 2 of 5



POSTNET



Customer bar code



Customer bar code of high priority



KIX Code

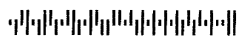

RM4SCC



Data Matrix



MicroQR



QR code



Micro PDF417



MaxiCode

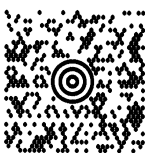

CP Code

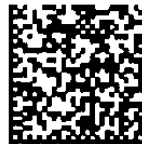

PDF417



• **GS1 DataBar family (with no compound composite printed)**

GS1 DataBar (Truncated)



GS1 DataBar Stacked



GS1 DataBar Stacked Omnidirectional



GS1 DataBar Limited



GS1 DataBar Expanded



GS1 DataBar Expanded Stacked



UPC-A

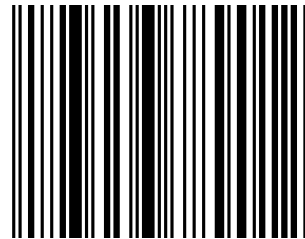

UPC-E

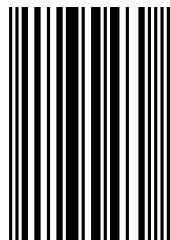

EAN-13

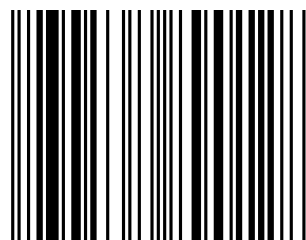

EAN-8

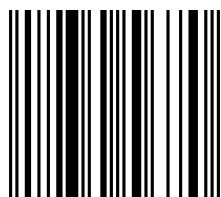

UCC/EAN-28 with CC-A, CC-B, or CC-C



• **GS1 DataBar family (with compound composite printed)**

GS1 DataBar (Truncated)



GS1 DataBar Stacked



GS1 DataBar Stacked Omnidirectional



GS1 DataBar Limited



GS1 DataBar Expanded



GS1 DataBar Expanded Stacked

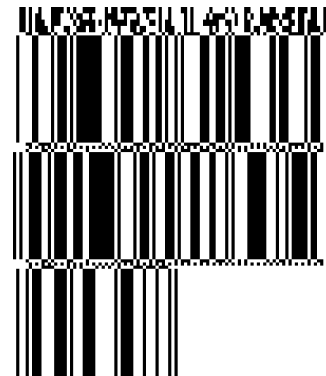

UPC-A



UPC-E



EAN-8



EAN-13



UCC/EAN-128 with CC-A or CC-B



UCC/EAN-128 with CC-C



APPENDIX 4 GLOSSARIES

Barcode

A code which represents alphanumeric characters by using a series of black and white stripes of different widths. Reading barcodes is a fast and accurate means of capturing data.

Batch mode

An issue mode that continuously prints until the specified number has been printed.

Black mark

A black mark printed on the media so that the printer can maintain a consistent print position by detecting this mark.

Black mark sensor

A reflective sensor that detects the difference of potential between the black mark and print area to find the print start position.

Built-in rewinder mode

A printer mode where media is wound onto the build-in rewinder.

Cut mode

A printer mode where an optional cutter module is installed to automatically cut media from the supply roll after they are printed. The print command can specify to cut after every print or to cut after a set number of prints.

Cutter module

A device used to cut the media.

DHCP

Dynamic Host Configuration Protocol

A communications protocol that allocates an IP address to a computer plugged into a network.

DPI

Dots Per Inch

The unit used to express print density.

Expansion I/O interface

An interface circuit that may be installed to allow the printer to be connected to an external device such as a wrapping machine. It can receive feed, print start, and pause signals from the external device and to send back print, pause, and error status signals to the external device.

Feed gap sensor

A transmissive sensor that detects the difference of potential between the gap between labels and the label to find the print start position.

Font

A complete set of alphanumeric characters in one style of type. E.g. Helvetica, Courier, Times

Gap

Gap between labels on a backing material

IPS

Inch per second

The unit used to express print speed.

Label

A type of media with adhesive backing.

LCD

Liquid Crystal Display

Installed on the operation panel and displays operation modes, error message etc.

Media

Material on which data is printed by the printer. Labels, tag paper, fanfold paper, perforated paper etc.

Plug and Play

When Plug and Play is enabled, the PC will automatically identify the printer (if the PC supports Plug & Play), optimise the system resource (IRQ and DMA), and display a message prompting a printer driver installation.

Pre-printed media

A type of media on which characters, logos, and other designs have been already printed.

Printer IP address

A 32-bit address of a printer connected to TCP/IP network, which identifies the printer. An IP address is written as 4 sets of numbers, separated by full stops. For example 192.168.10.20.

Print head element

The thermal print head consists of a single line of tiny resistive elements. When current is allowed to flow through each element it heats up causing a small dot to be burned onto thermal paper or a small dot of ink to be transferred from a thermal ribbon.

Print speed

The speed at which printing occurs. This speed is expressed in units of IPS (inches per second).

Reflective sensor

See Black mark sensor.

Resolution

The number of individual dots a printer can produce within a unit of distance. Printer resolution measured in Dots per Inch. As the number of dots per inch increases, the resolution increases, resulting in a more detailed image.

RFID (Radio Frequency Identification)

RFID is a technology that uses radio waves to exchange data between a reader and an electronic tag. The tag can be encapsulating inside a label which can also be printed on. RFID is very useful for object identification and tracking.

Ribbon

An inked film used to transfer an image or text onto media. In thermal transfer printing, it is heated by the print head, causing an image to be transferred onto the media.

Strip mode

The printer removes labels from the backing paper. After each issue the printer stops until the label is removed. Once the label is removed the next label will be issued and so on.

Supplies

Media and ribbon

Tag

A type of media with no adhesive, usually made from cardboard or other durable material.

Thermal direct printing

A printing method using no ribbon and thermal media which reacts to heat. The print head makes direct contact with the media producing text or images.

Thermal print head

A print head using thermal transfer or thermal direct printing method.

Thermal transfer printing

A printing method where the thermal print head heats an ink or resin coated ribbon against the media. The ink/resin is then transferred onto the media.

Threshold setting

A sensor setting that allows the printer to maintain a consistent print position of pre-printed media.

Transmissive sensor

See Feed gap sensor.

USB (Universal Serial Bus)

An interface that is used to connect peripherals, such as a printer, keyboard, mouse to computer or host. The USB port may allow disconnection of a USB device without turning off the power.

Web printer

The web printer function allows you to browse the printer status on the PC, issue media, check or change the settings, or download firmware to the printer. For details, refer to the **Network Specification**.

